

ISTRUZIONI DI MONTAGGIO

ASSEMBLY INSTRUCTION

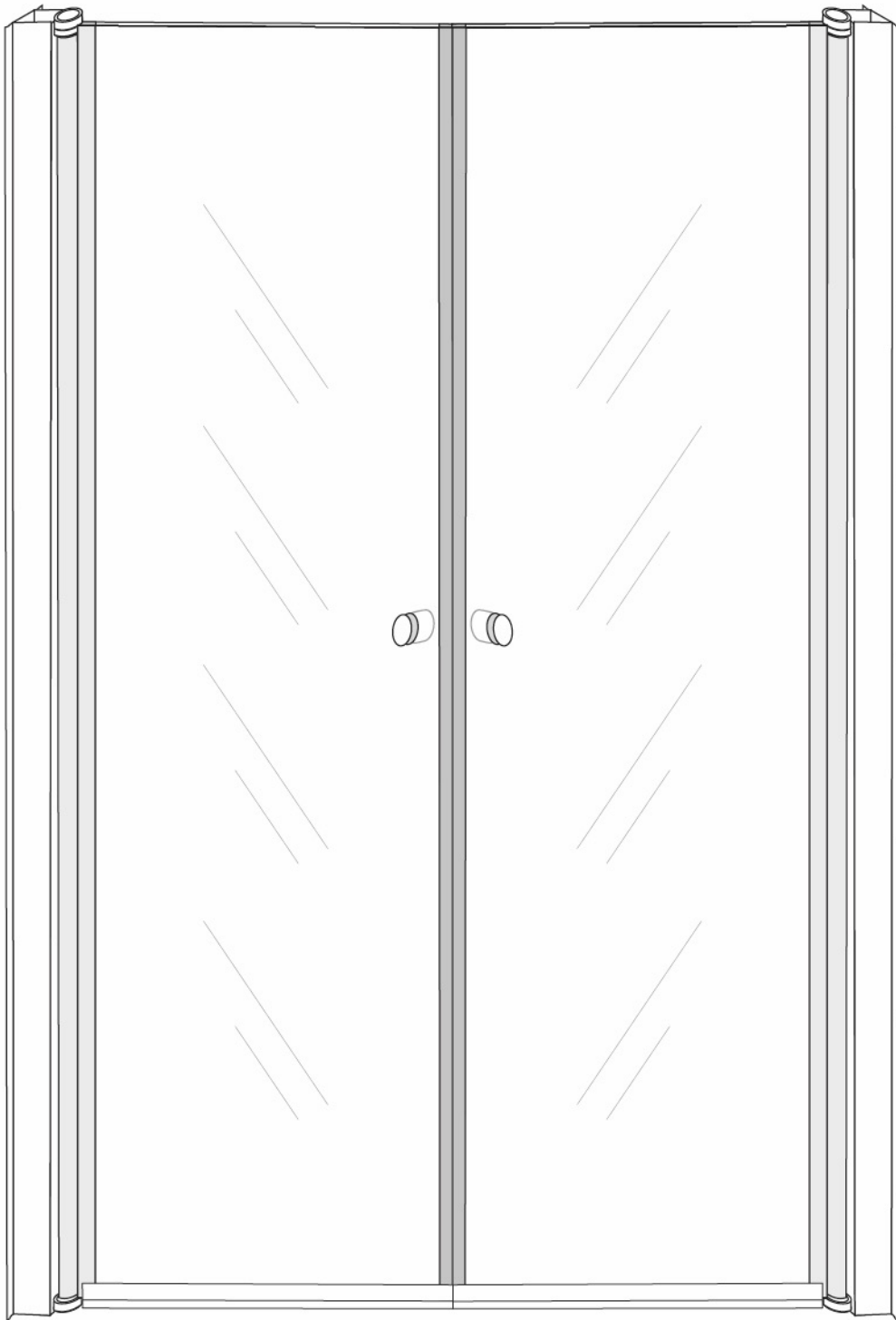

Livella
Level ruler

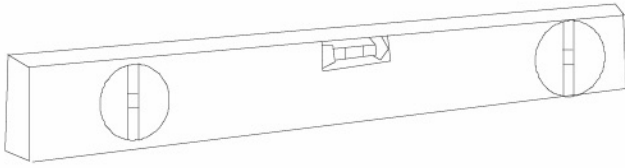

Metro a nastro
Tap measure



Cacciavite
Screwdriver

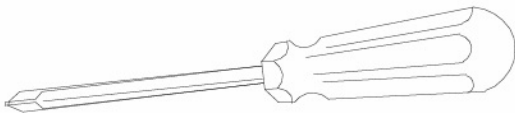

Matita
Pencil



Punta del trapano
da 5.5 mm
5.5 mm drills



Trapano elettrico
Electric drill

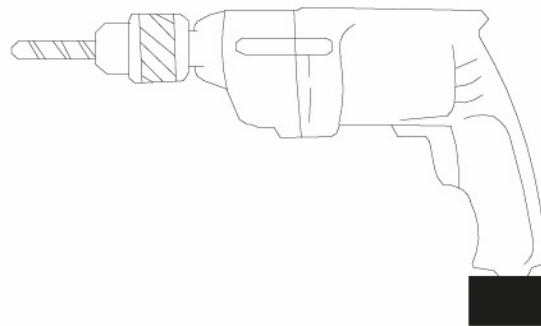

Martello di gomma
Rubber mallet

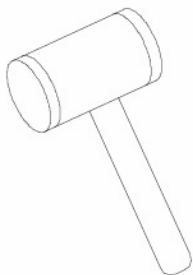

Pistola per silicone
Organic glass gun

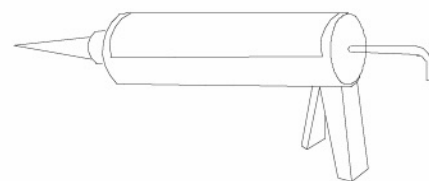



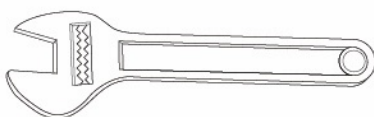

Chiave inglese
Spanner

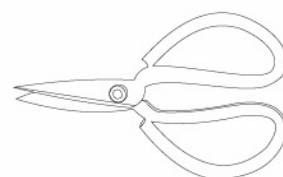

Forbici
Scissors

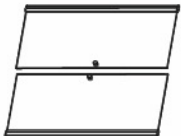
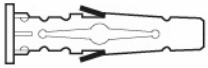

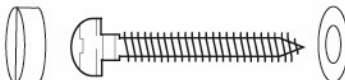
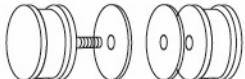
Fitting kit includes - Kit di montaggio incluso

| NR. seriale Serial NO. | Nome - Name | Rendering | Q.tà Qty. |
|---------------------------|---|--|--------------|
| A1 | Profilo a muro Wall profile |  | 2 |
| B1 | Porta fissa Fixed glass |  | 2 |
| A2 | Tassello a espansione verde Green expandable wall plug |  | 8 |
| B2 | Viti 4x25 Screws 4x25 |  | 8 |
| C2 | Viti 4x10 Screws 4x10 |  | 8 |
| D2 | Maniglie handles |  | 2 |
| E2 | Profilo para-acqua Breakwater profile |  | 2 |
| F2 | Punta da trapano da 3 mm Drill bit 3 mm |  | 1 |

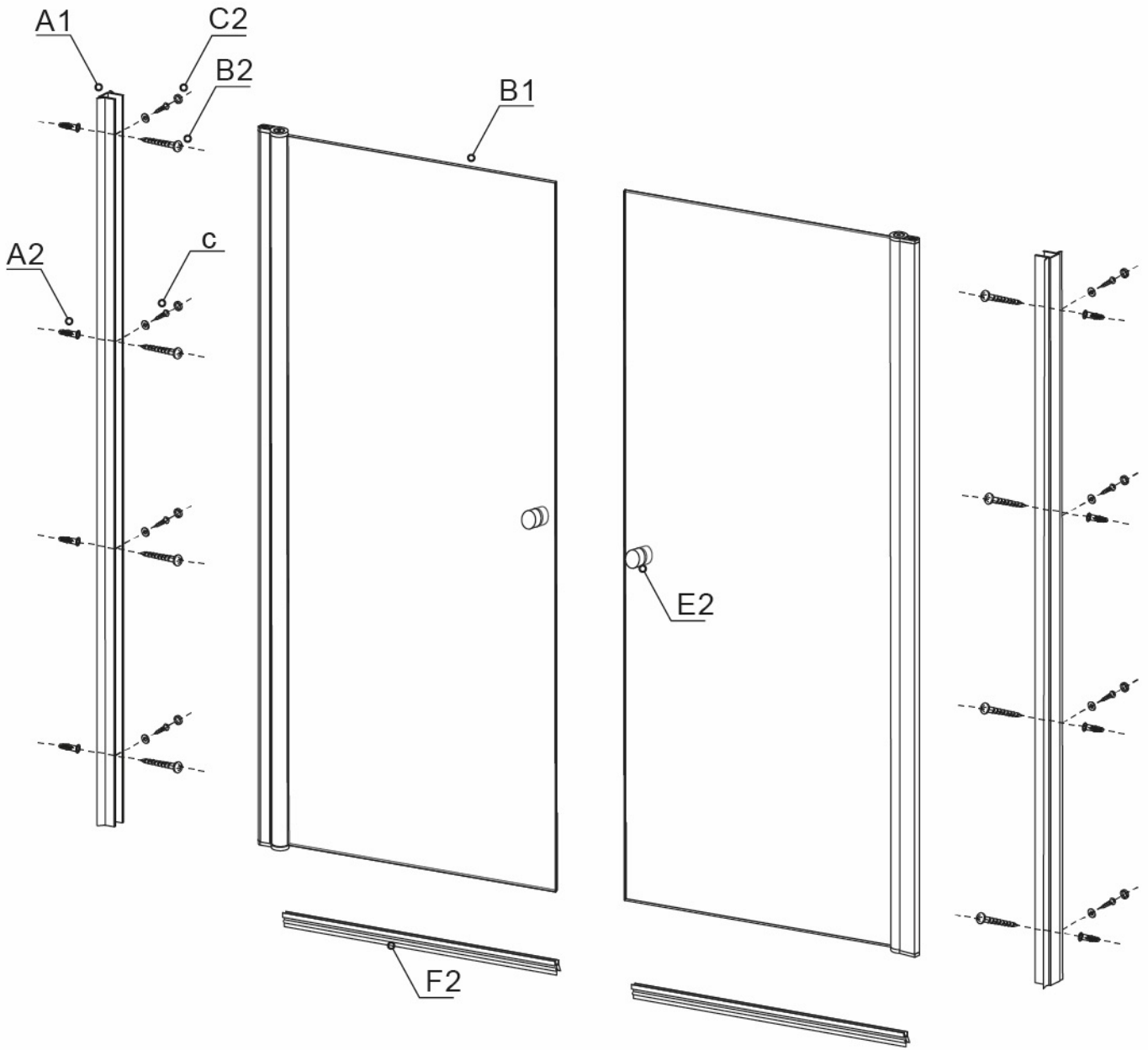

1

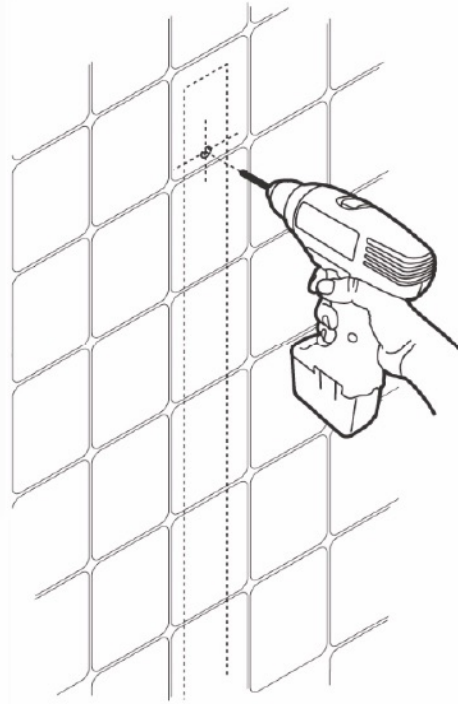
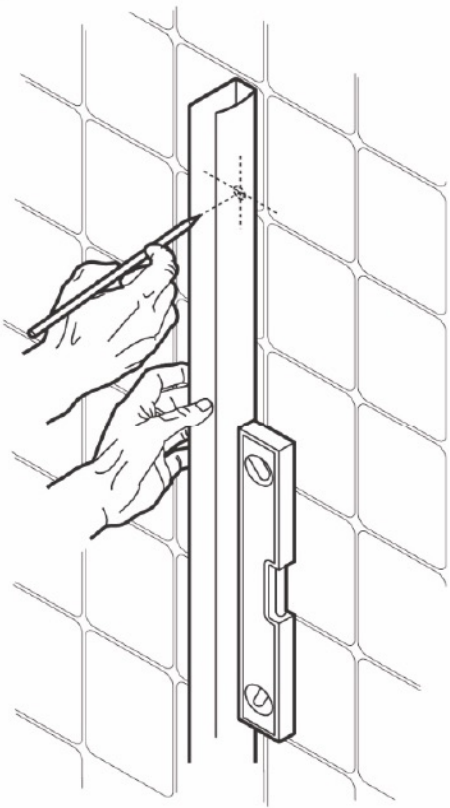

2

X8

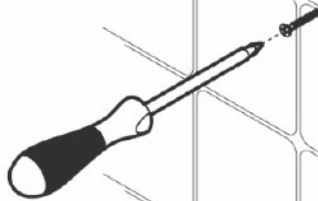

4x25



