

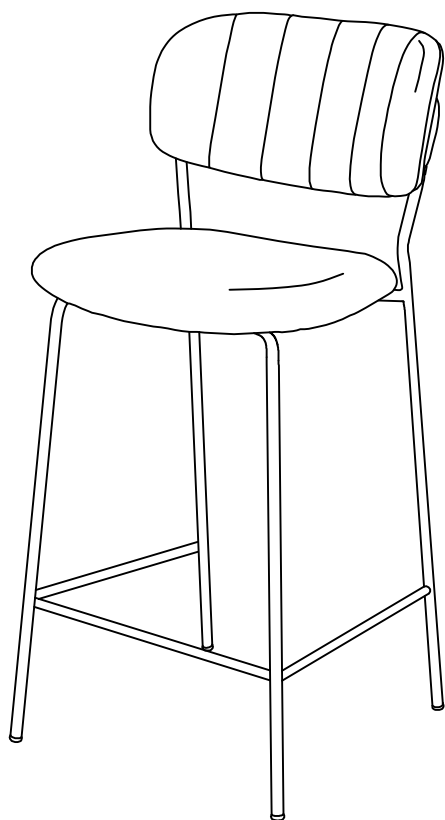

1001210 Alicante

**HOUSE
NORDIC**

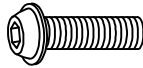

A		x4
B		x4
C		x1

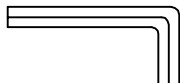