

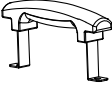









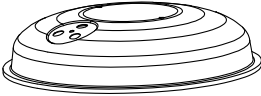
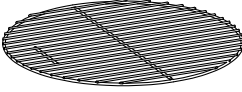

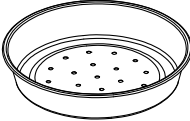
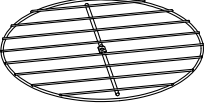

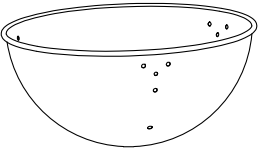









Barry barbecue

---









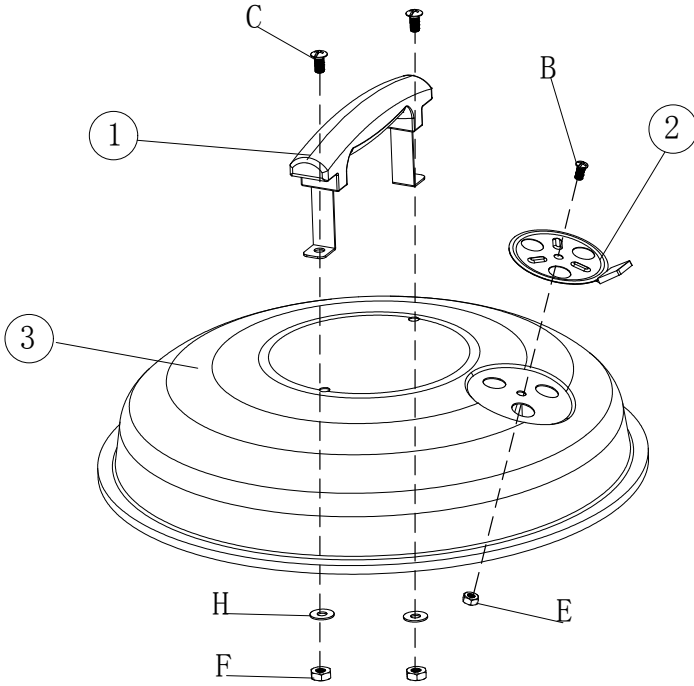

1		1X
2		1X
3		1X
4		1X
5		1X
6		1X
7		1X
8		3X

9		3X	
10		1X	
11		1X	
12		3X	
A	M4X8	 	12X
B	M5X10	 	3X
C	M6X12	 	6X
D	M4	 	12X
E	M5	 	3X
F	M6	 	6X
G	Ø5.5XØ10X1	 	1X
H	Ø6XØ16X1	 	5X

DK  
NO  
SE  
FI  
GB  
DE  
ET  
ES  
NL

1



- |                |   |   |           |   |   |
|----------------|---|---|-----------|---|---|
| B (M5x10) x1   |  |  | E (M5) x1 |  |  |
| C (M6x12) x2   |  |  | F (M6) x2 |  |  |
| H (Ø6 x Ø16)x2 |  |  |           |   |   |

2

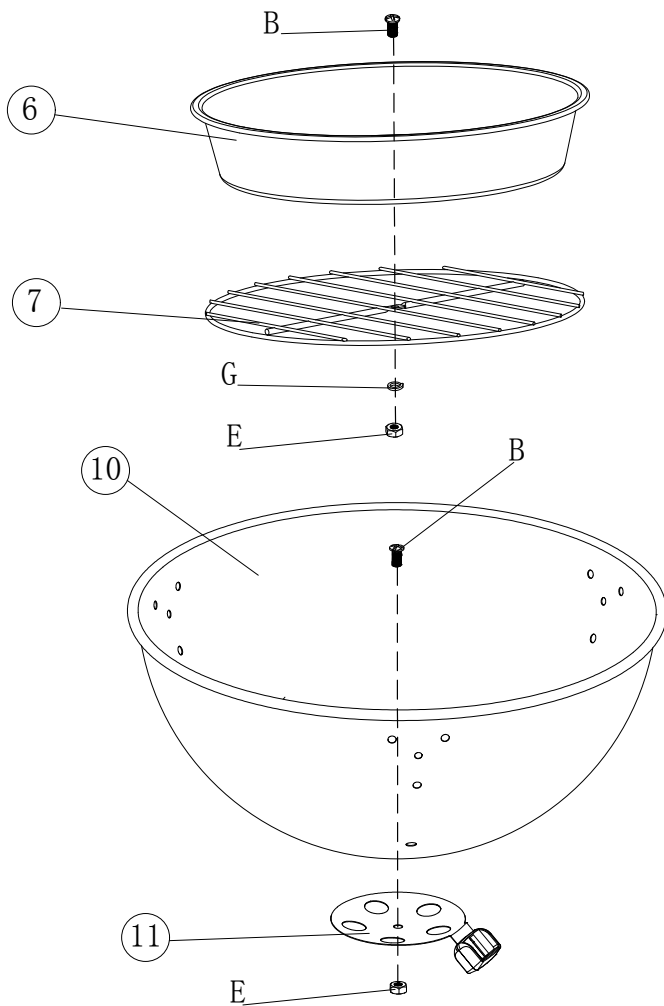

B (M5x10) x2



E (M5) x2



G (Ø5.5 xØ10)x1



DK

NO

SE

FI

GB

DE

ET

ES

NL

3

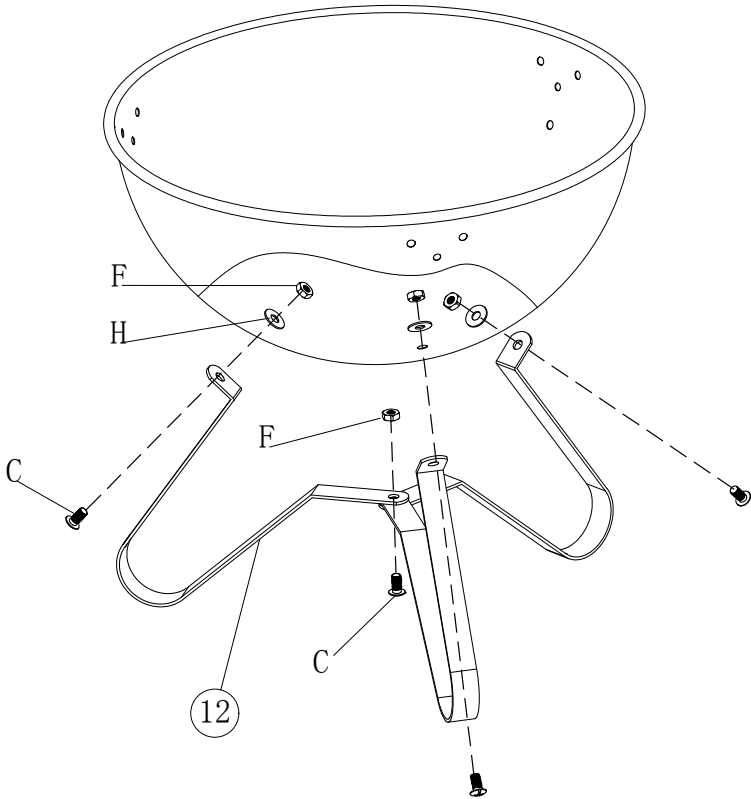

C (M6x12) x4



F (M6) x4



H (Ø6 xØ16)x3



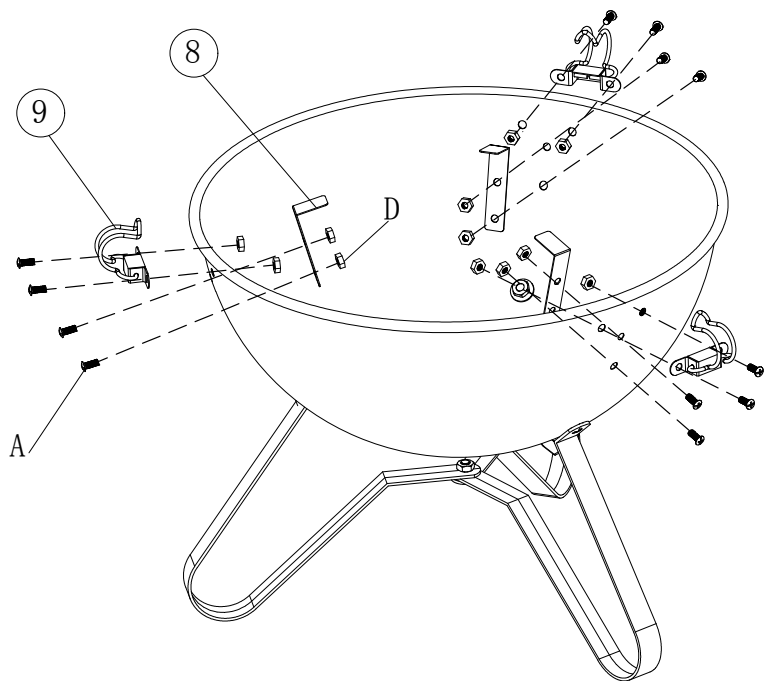

A (M4x8) x12



D (M4) x12



5

