

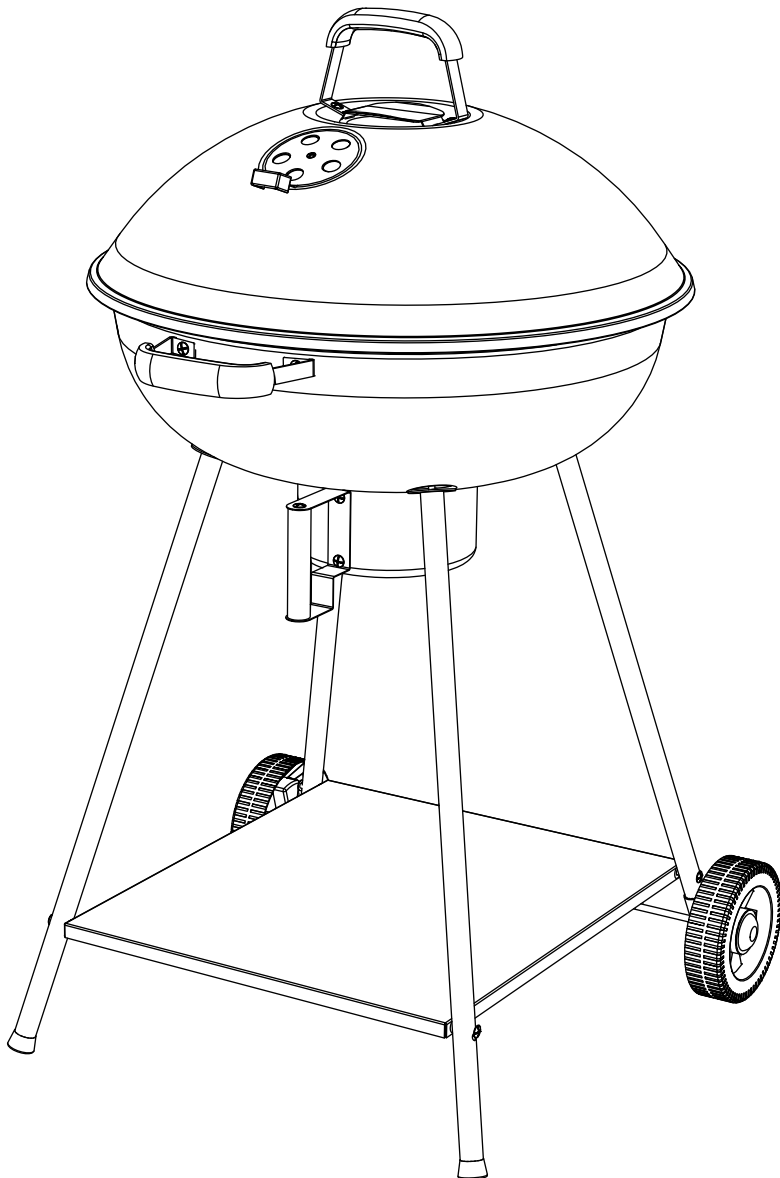

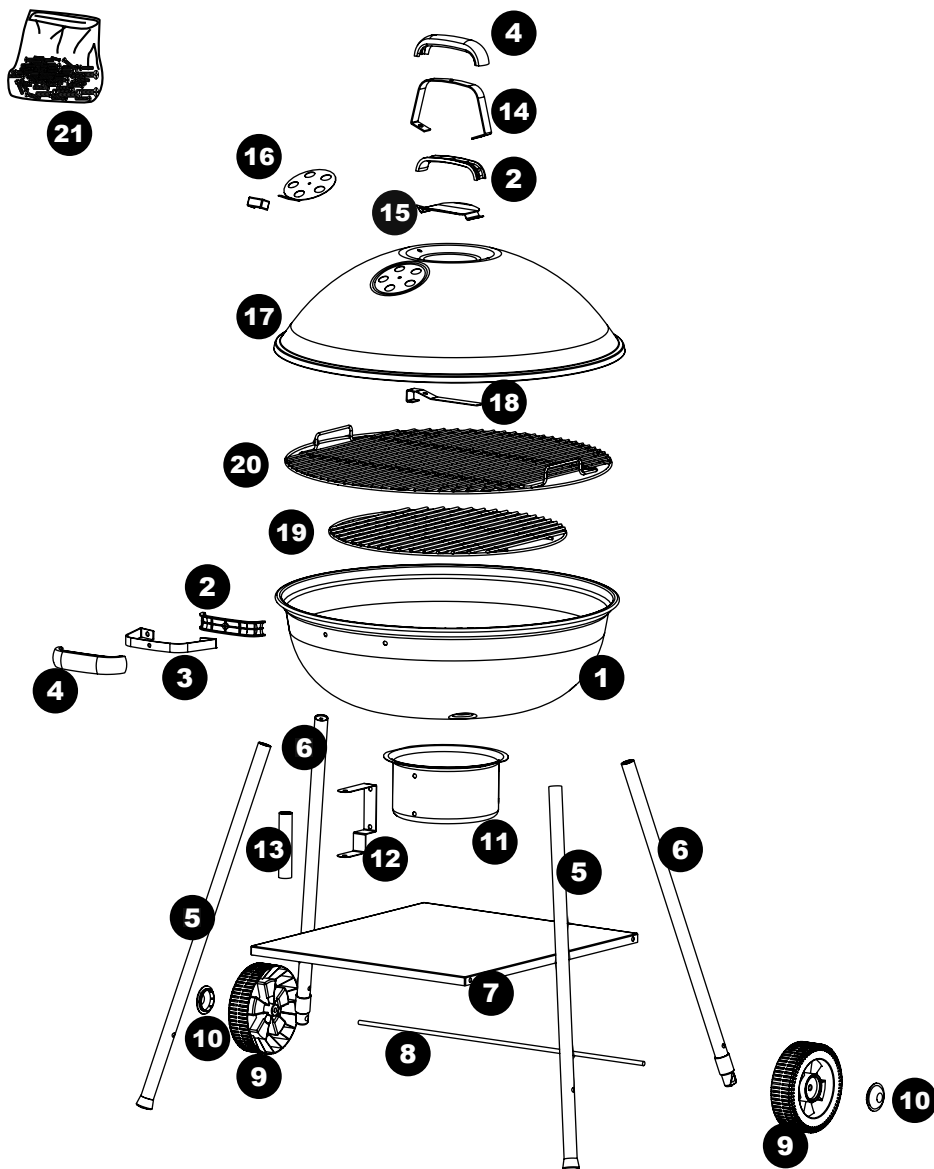











# TOM 355572i EN











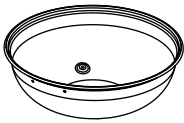
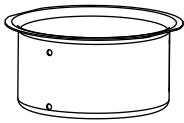

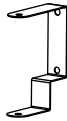
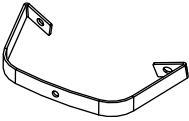





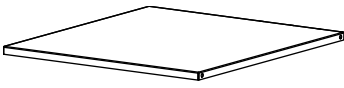
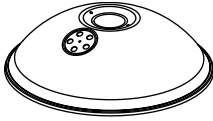
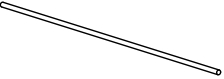
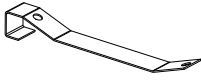

	6 x 30	4
	6 x 16	6
	6 x 12	6
	4 x 12	1
	3,5 x 9,5	2

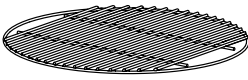
		Ø 25	8
	fibre	Ø 6	2
	fibre	Ø 4	1
		Ø 6	10
		Ø 4	1

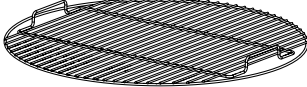
		Ø 8	2
	break nut/frein	Ø 4	1
		Ø 6	10

<b>1</b>		x 1	<b>11</b>		x 1
<b>2</b>		x 2	<b>12</b>		x 1
<b>3</b>		x 1	<b>13</b>		x 1
<b>4</b>		x 2	<b>14</b>		x 1
<b>5</b>		x 2	<b>15</b>		x 1
<b>6</b>		x 2	<b>16</b>		x 1
<b>7</b>		x 1	<b>17</b>		x 1
<b>8</b>		x 1	<b>18</b>		x 1
<b>9</b>		x 2	<b>19</b>		x 1
<b>10</b>		x 2	<b>20</b>		x 1
			<b>21</b>		x 1

- 1** 3,5 x 9,5    Ø6 x 12    Ø6    Ø6
- 
- x 1            x 2            x 2            x 2

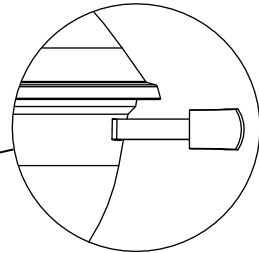
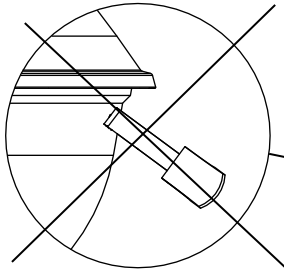
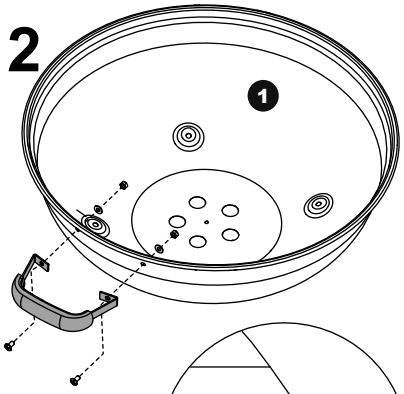
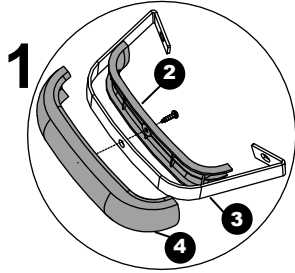

- 2** Ø6 x 16    Ø25
- 
- x 2            x 4

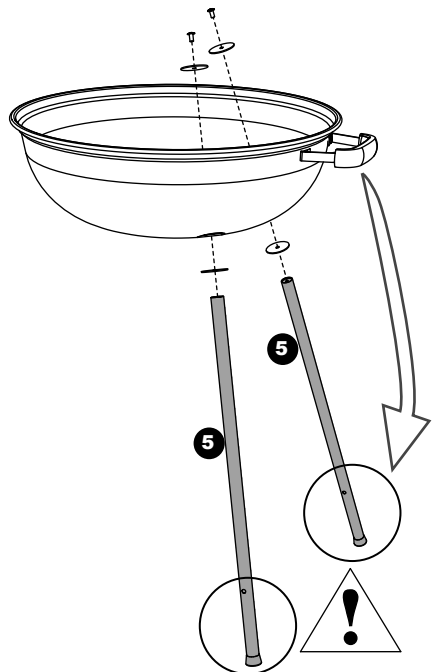

**3**

Ø6 x 16

Ø25



x 2

x 4

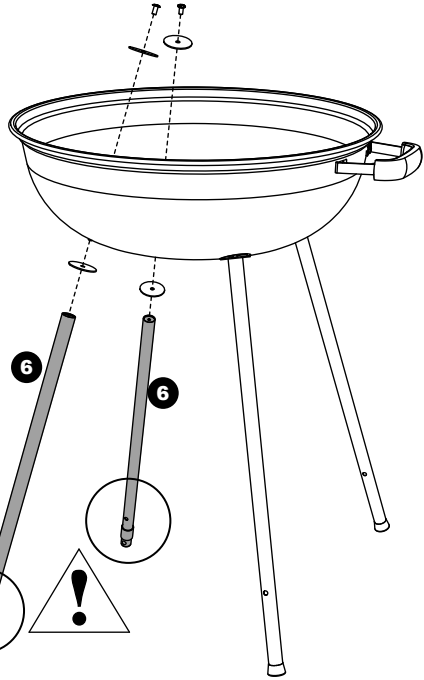
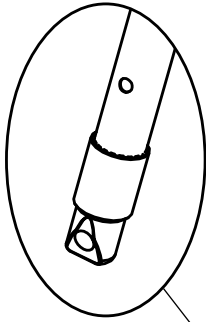
**4**

Ø6 x 30

Ø6

Ø6



x 4

x 4

x 4

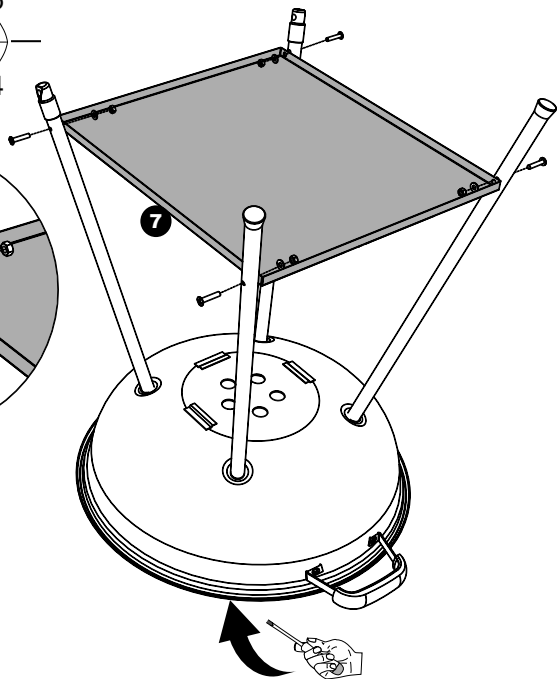
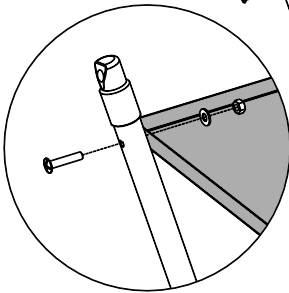

**5**

Ø8 Nylstop

x 2



10

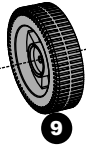

9

8



9

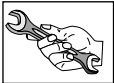

10

**6**

Ø6 x 12

Ø6

Ø6



x 4



x 2



x 2

13



12

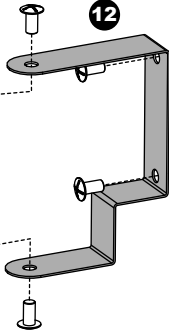

11

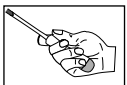
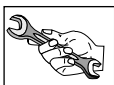
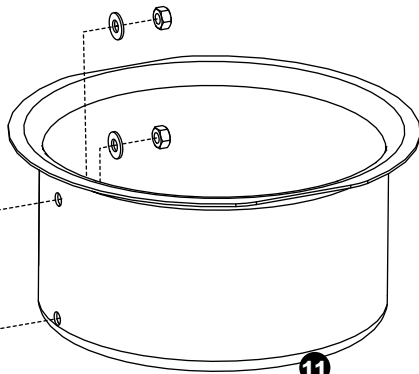

**7**

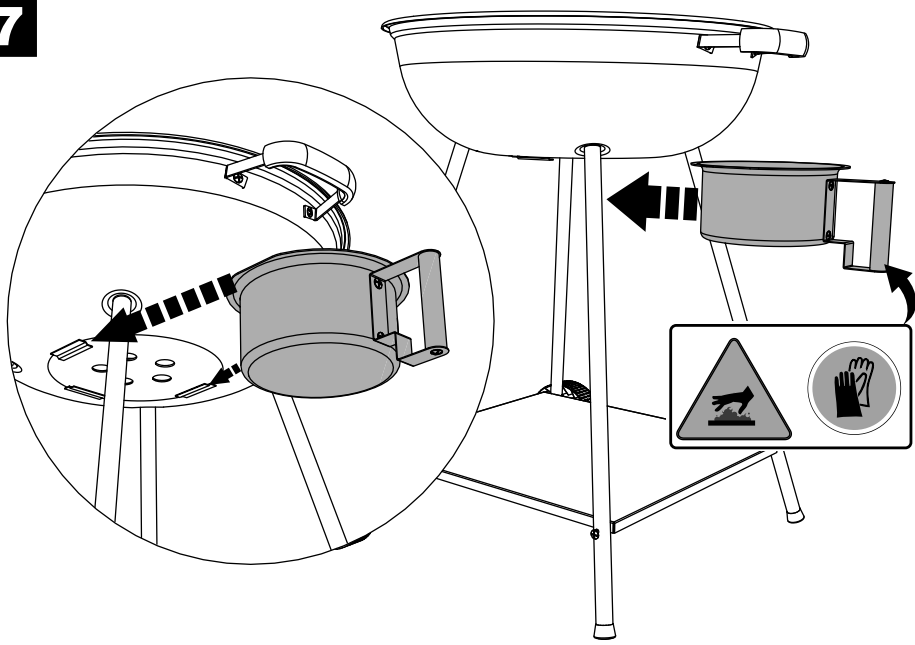

**8**

- $3,5 \times 9,5$ 

 $\text{Ø}6 \times 16$ 

 $\text{Ø}6$ 

 $\text{Ø}6$ 

 $\text{Ø}6$
- x 1a
  x 2b
  x 2d
  x 2e
  x 2f
- Fibre  
Fiber
- x 1c
  x 1g
  x 1h
  x 1 break nut / frein
- Fibre  
Fiber

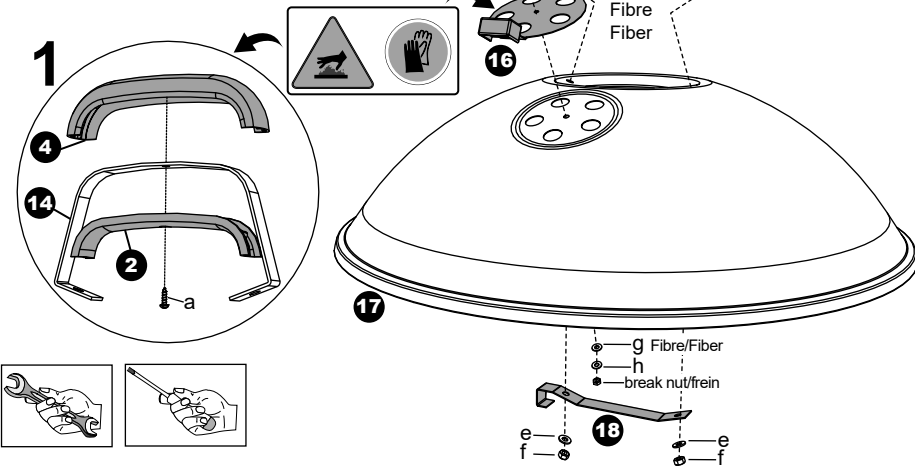

9

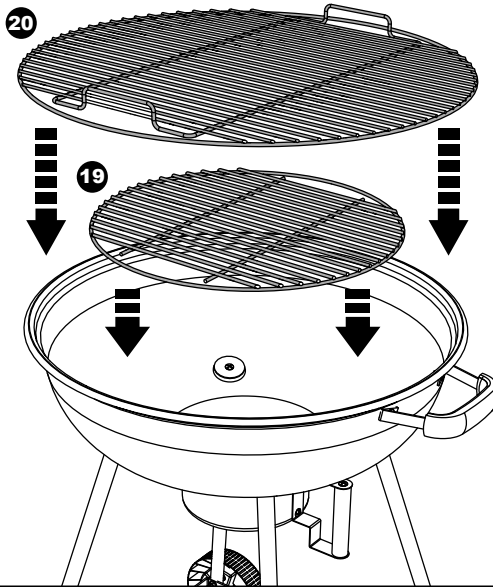

10

