

YS-HU1-GM132

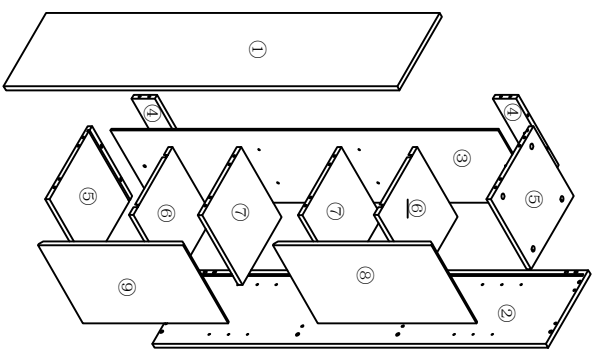

Order	(L*W) MM
①	1315*283=1
②	1315*283=1
③	1295*280=1
④	270*78=2
⑤	270*283=2
⑥	269*261=2
⑦	270*262=2
⑧	530*300=1
⑨	485*300=1

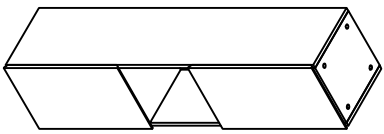
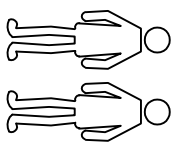
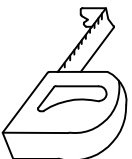
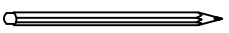
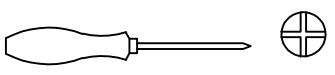
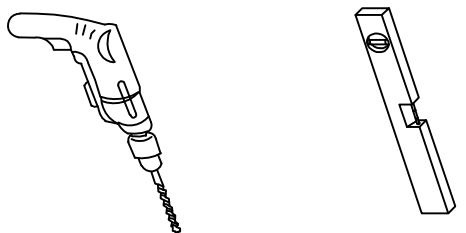

A **V** **C** **F**

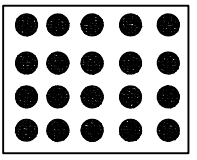
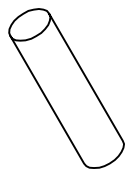
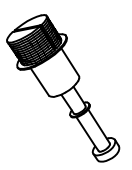

∅15*13mm =28
 ∅8*40mm =28
 ∅8*40mm =16
 ∅20*0.3mm=28

G **I** **J** **K**

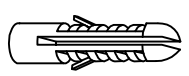
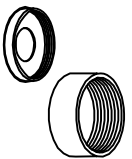
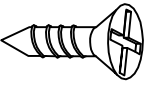
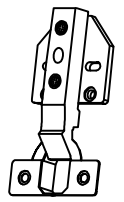

25*65*25mm =4
 4*14mm =28
 ∅20*8mm =2
 ∅10*43mm =2

L **N-N**

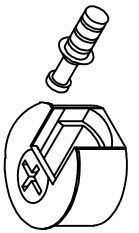
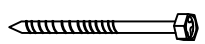

∅6*70mm =2
 ∅20*10mm =8

1

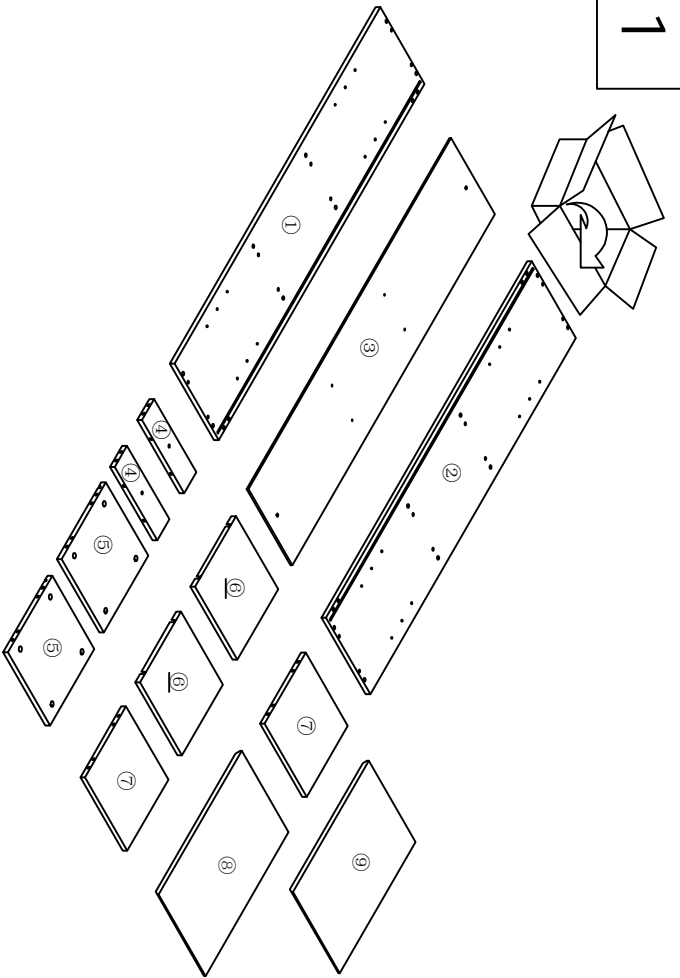

2

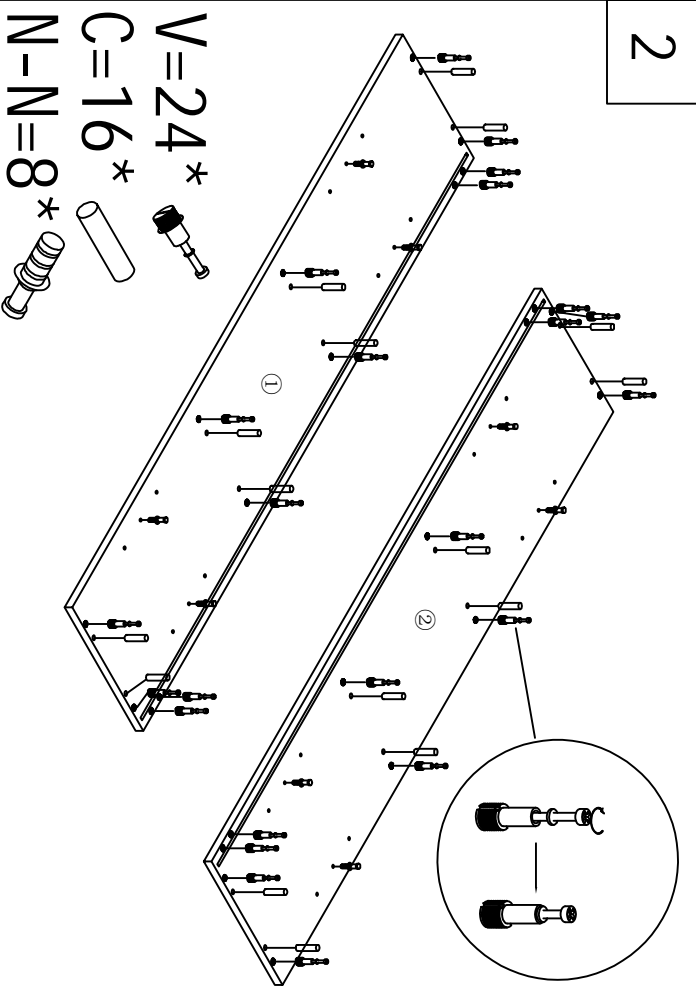

$V=24^*$
 $C=16^*$
 $N-N=8^*$

3

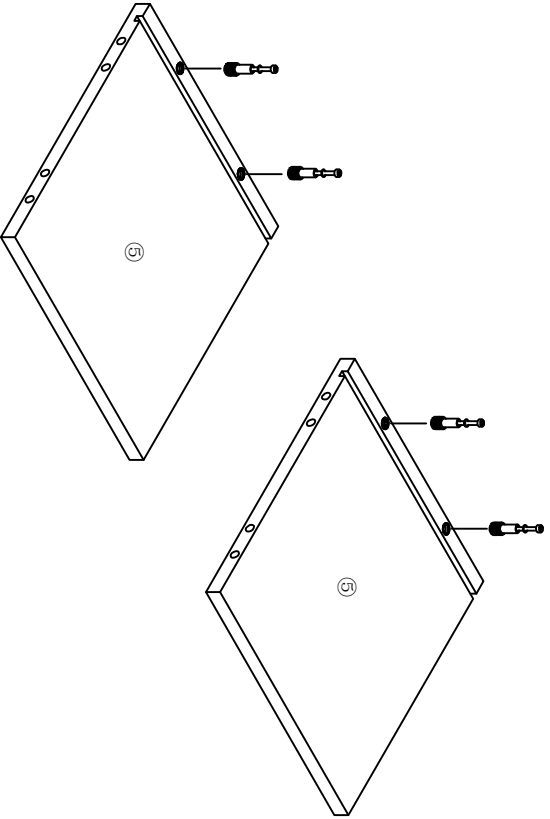

$V=4^*$



4

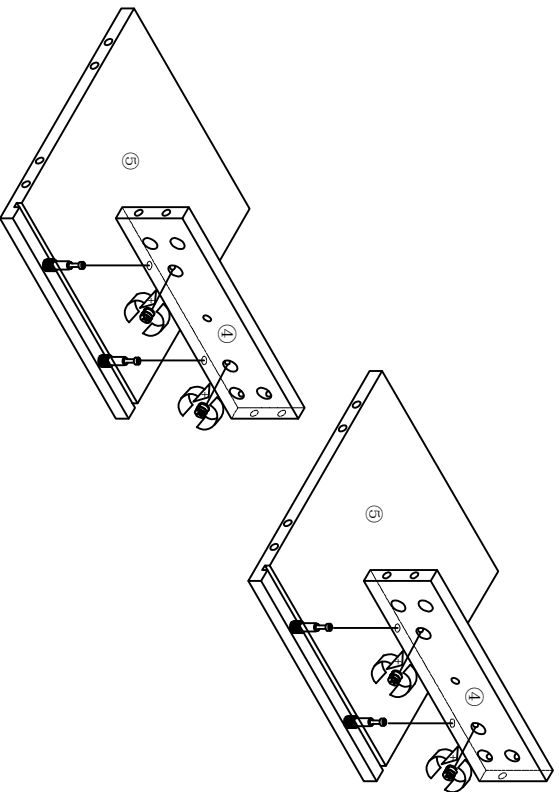

$A=4^*$



5

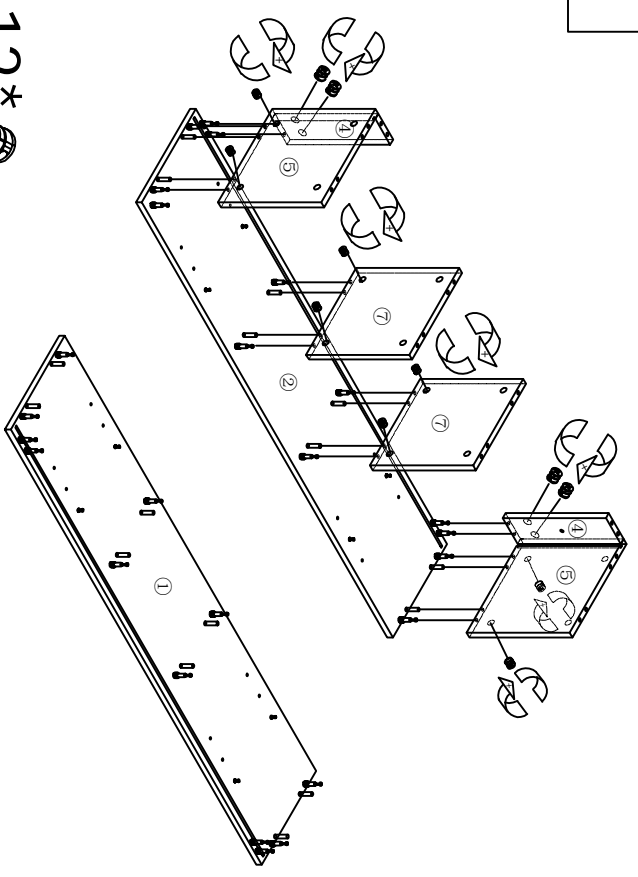

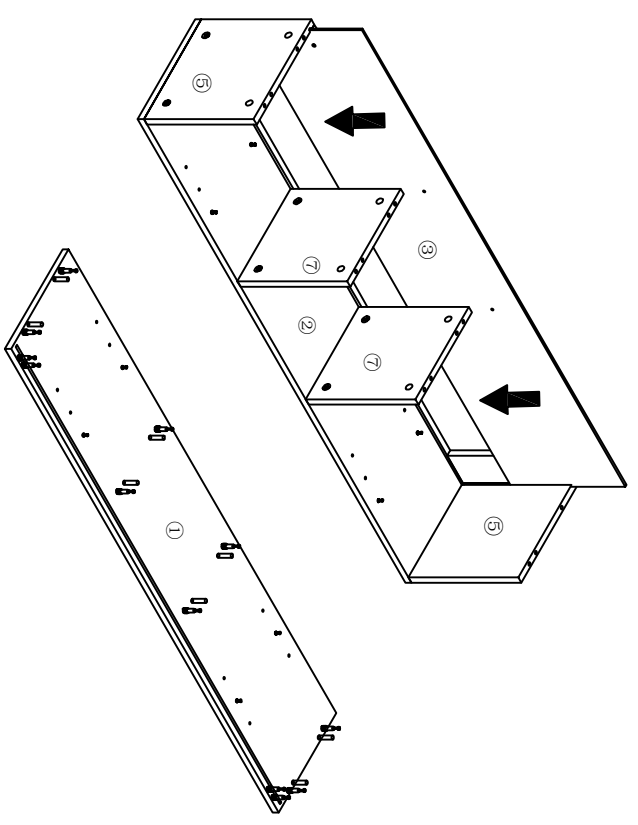

A=12* 

6



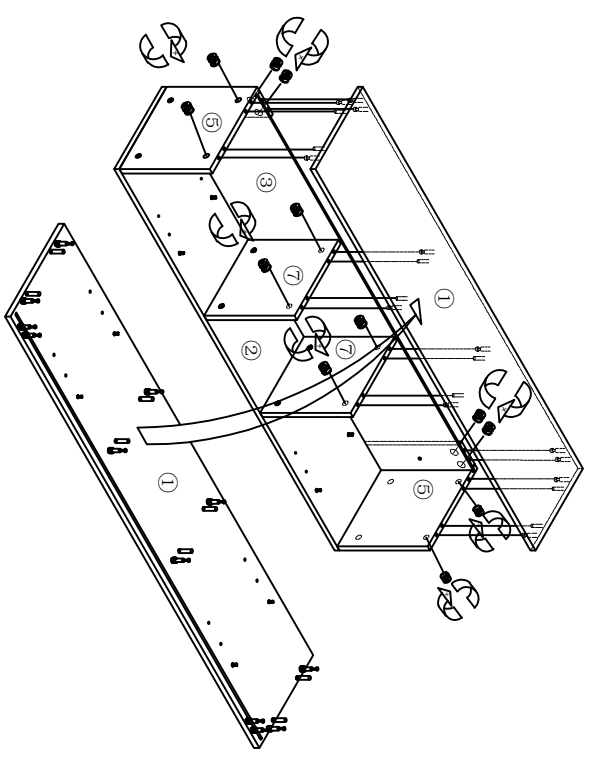

7

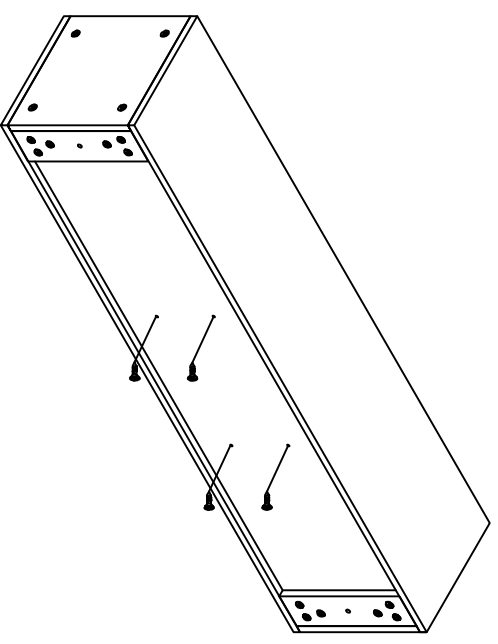

A=12* 

8



I=4* 

9

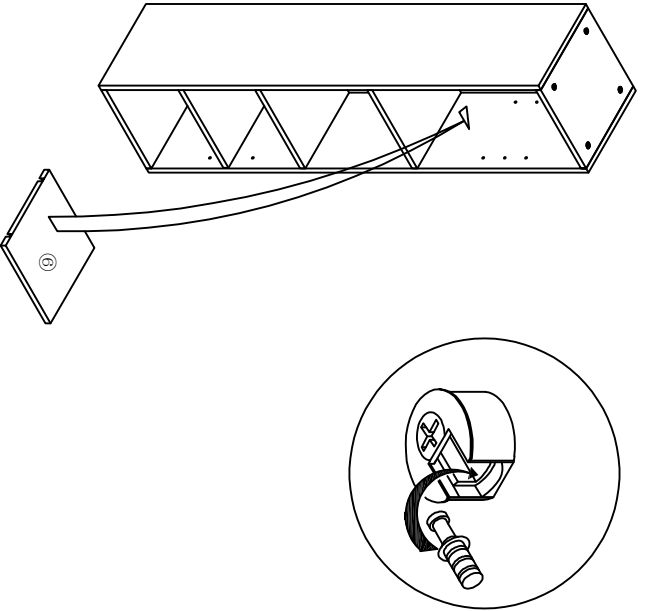

10

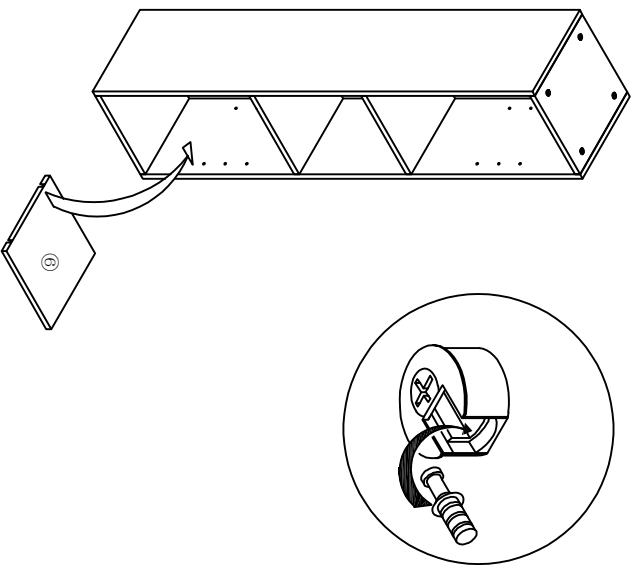

11

In same level

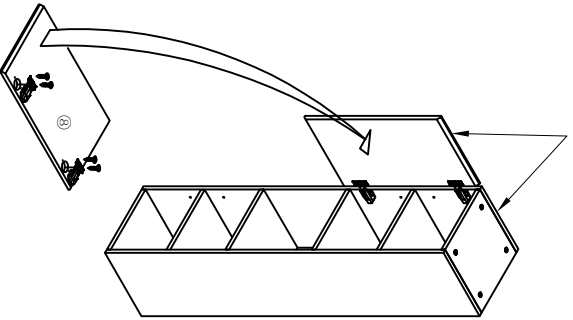

G=2*
I=12*

12

In same level

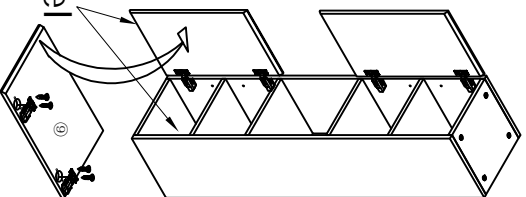

G=2*
I=12*

13

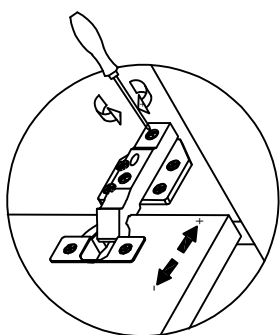
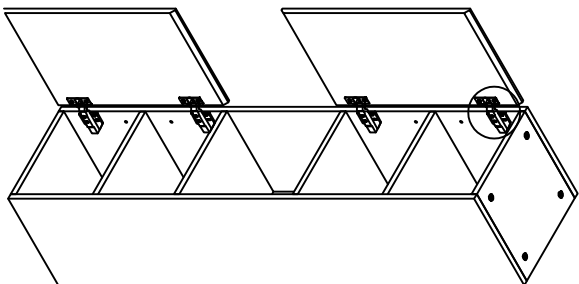

14

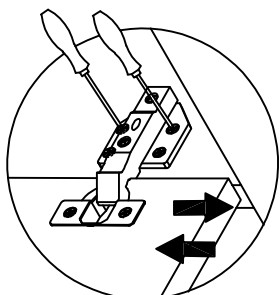
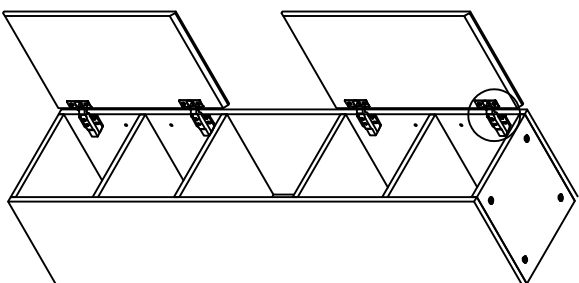

15

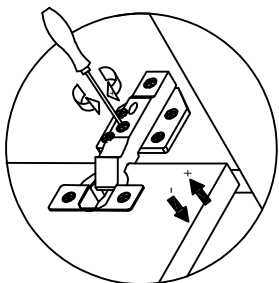
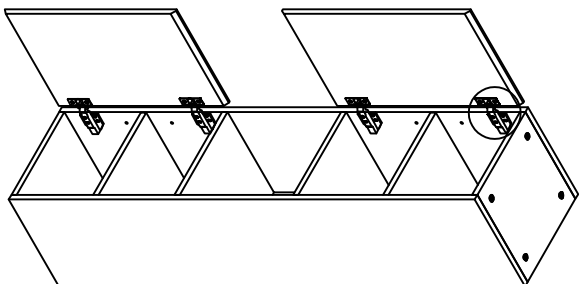

16

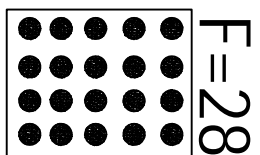
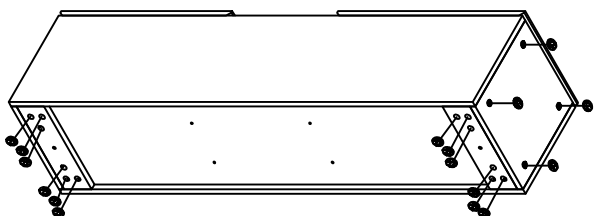

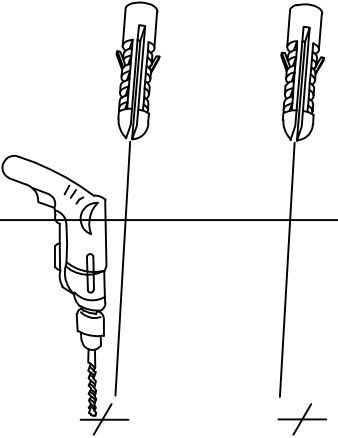

17

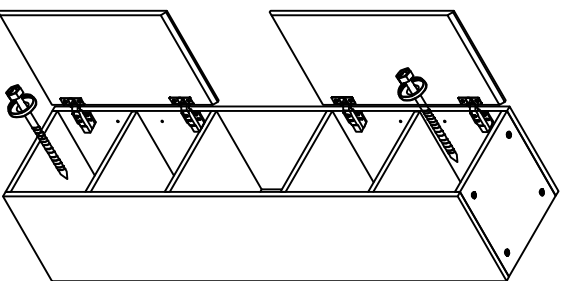

18



K=2*



L=2*
J=2*
 

19

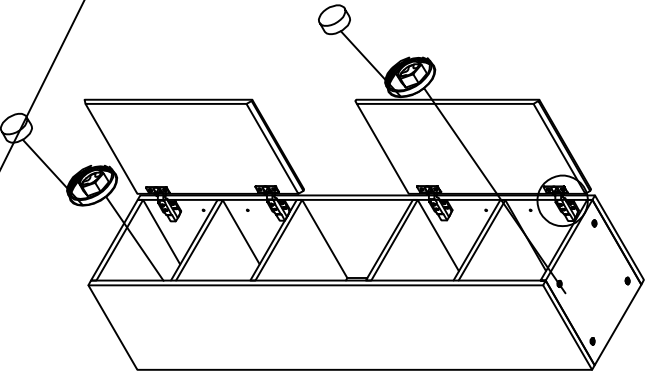
J=2*

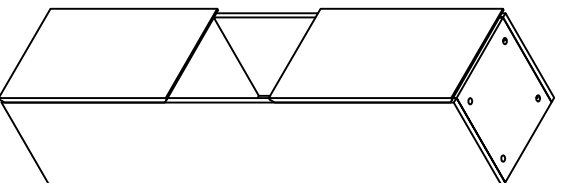

20



OK!