

INSTRUCTION MANUAL/BEDIENUNSANLEITUNG/NOTICE D'UTILISATION/  
MANUAL DE INSTRUCCIONES DE USO/MANUALE DI ISTRUZIONI

**! WARNING!**

Adults assembly required.  
During assembly, keep all  
parts away from children.  
Check regularly to ensure  
all fasteners are tight.

**! WARNUNG!**

Die Montage ist von  
Erwachsenen durchzuführen.  
Halten Sie während der  
Montage alle Teile von Kindern  
fern.  
Überprüfen Sie regelmäßig  
den festen Sitz der Schrauben.

**! Attention!**

Montage à effectuer par  
des adultes.  
Pendant le montage, tenez  
les éléments  
éloignés des enfants.  
Vérifiez régulièrement que  
toutes les vis  
soient serrées.







**! ¡Atención!**



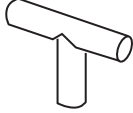

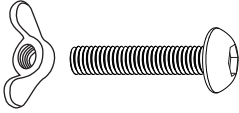

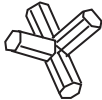
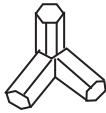
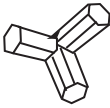







Se requiere que el montaje sea  
llevado a cabo por un adulto.  
Durante el montaje, mantenga  
todas las piezas fuera del  
alcance de los niños.  
Verifique regularmente que  
todos los tornillos estén  
correctamente apretados.

**! Avvertimento!**

L'assemblaggio deve essere  
effettuato da adulti.  
Durante il montaggio  
mantenere tutti i pezzi lontano  
dalla portata dei bambini.  
Controllare regolarmente per  
assicurarsi che tutte le  
chiusure siano ben strette.

**PARTS LIST/STÜCKLISTE/PARTS LIST/LISTA DE PIEZAS/LISTA DEI PEZZI**

<p><b>A</b></p>  <p>4pcs</p>	<p><b>B</b></p>  <p>1pc</p>	<p><b>C</b></p>  <p>1pc</p>
<p><b>D</b></p>  <p>8pcs</p>	<p><b>E</b></p>  <p>11pcs</p>	<p><b>F</b></p>  <p>8pcs</p>
<p><b>G</b></p>  <p>4pcs</p>	<p><b>H</b></p>  <p>1pc</p>	<p><b>I</b></p>  <p>2pcs</p>
<p><b>J</b></p>  <p>2pcs</p>	<p><b>K</b></p>  <p>1pc</p>	<p><b>1</b></p>  <p>99.2cm 1pc</p>

<p>②</p>  <p>99.2cm                      1pc</p>	<p>③</p>  <p>96.5cm                      6pcs</p>	<p>④</p>  <p>84.5cm                      4pcs</p>
<p>⑤</p>  <p>84cm                              2pcs</p>	<p>⑥</p>  <p>64cm                              2pcs</p>	<p>⑦</p>  <p>84cm                              1pc</p>
<p>⑧</p>  <p>84.5cm                      1pc</p>	<p>⑨</p>  <p>74cm                              1pc</p>	<p>⑩</p>  <p>77cm                              1pc</p>
<p>⑪</p>  <p>72.7cm                      2pcs</p>	<p>⑫</p>  <p>72.7cm                      2pcs</p>	<p>⑬</p>  <p>94.5cm                      4pcs</p>
<p>⑭</p>  <p>72cm                              2pcs</p>	<p>⑮</p>  <p>74cm                              7pcs</p>	

ASSEMBLY/MONTAGE/ASSEMBLAGE/MONTAJE/ASSEMBLAGGIO

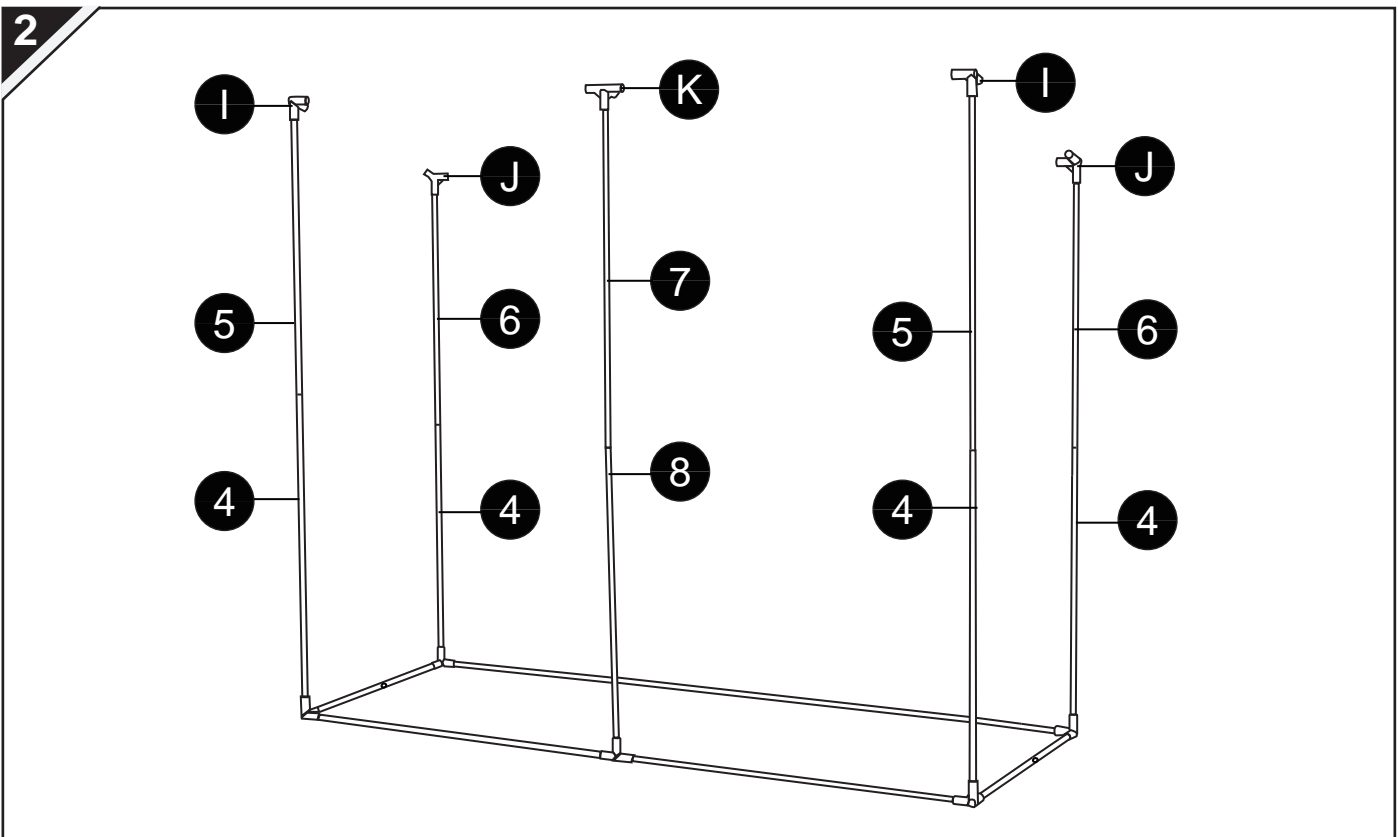
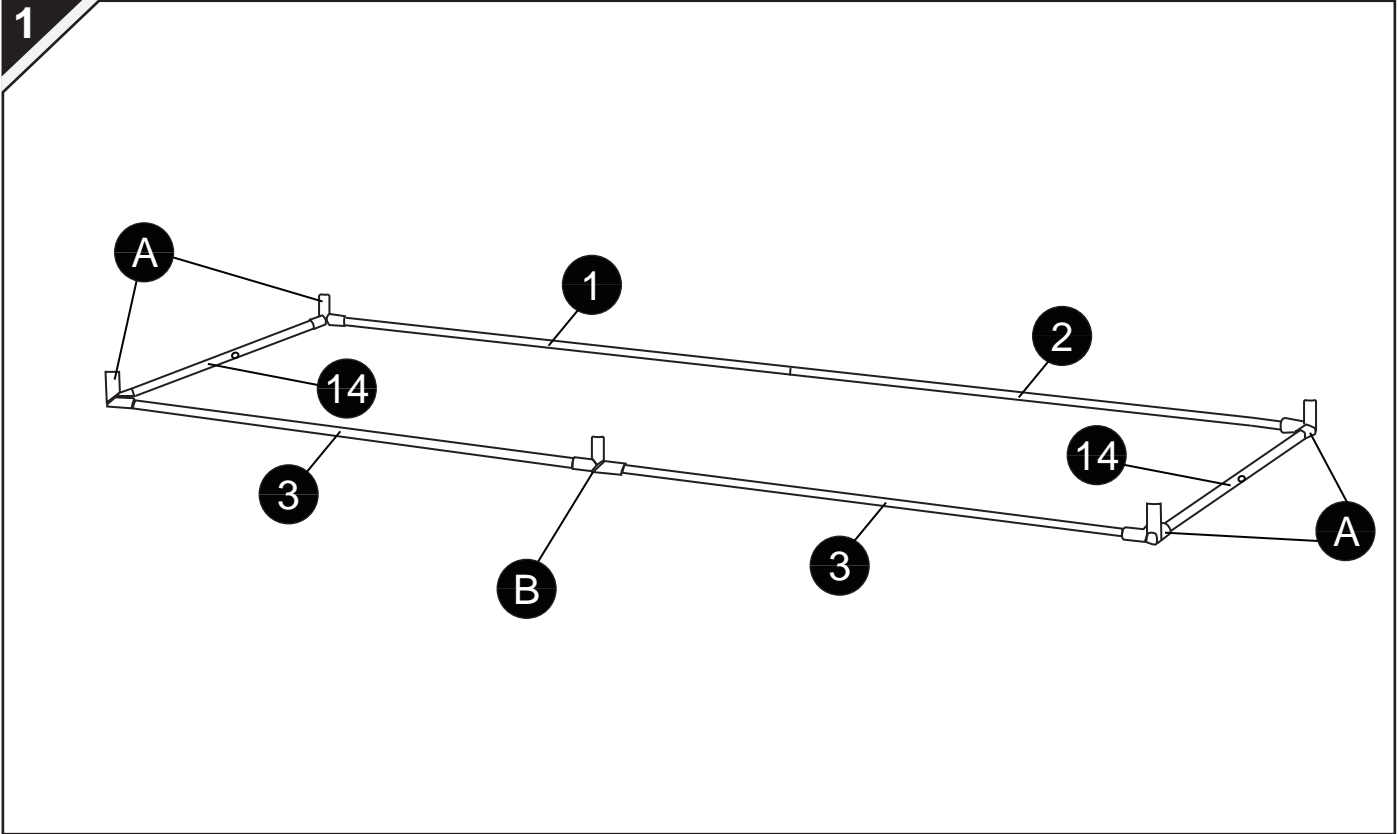

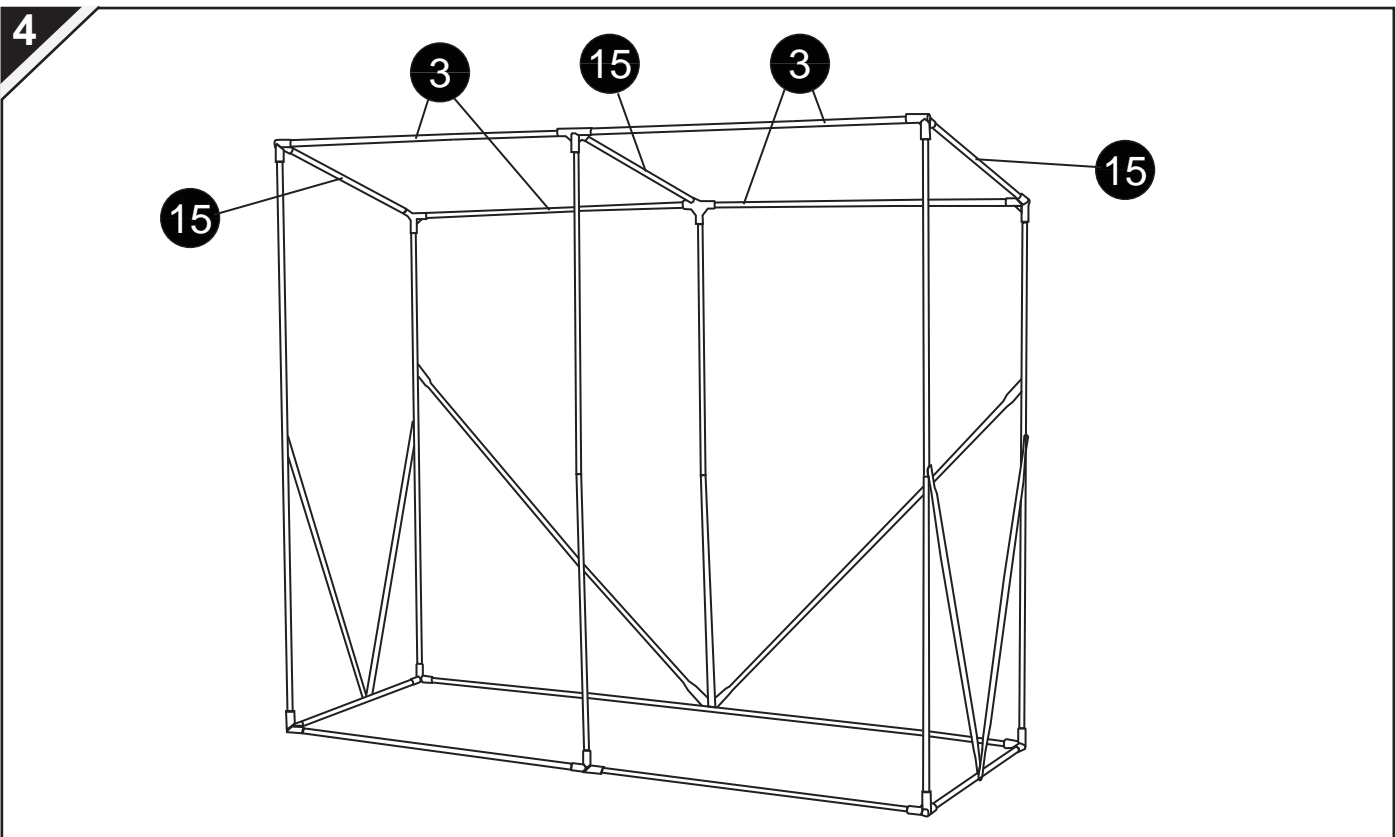
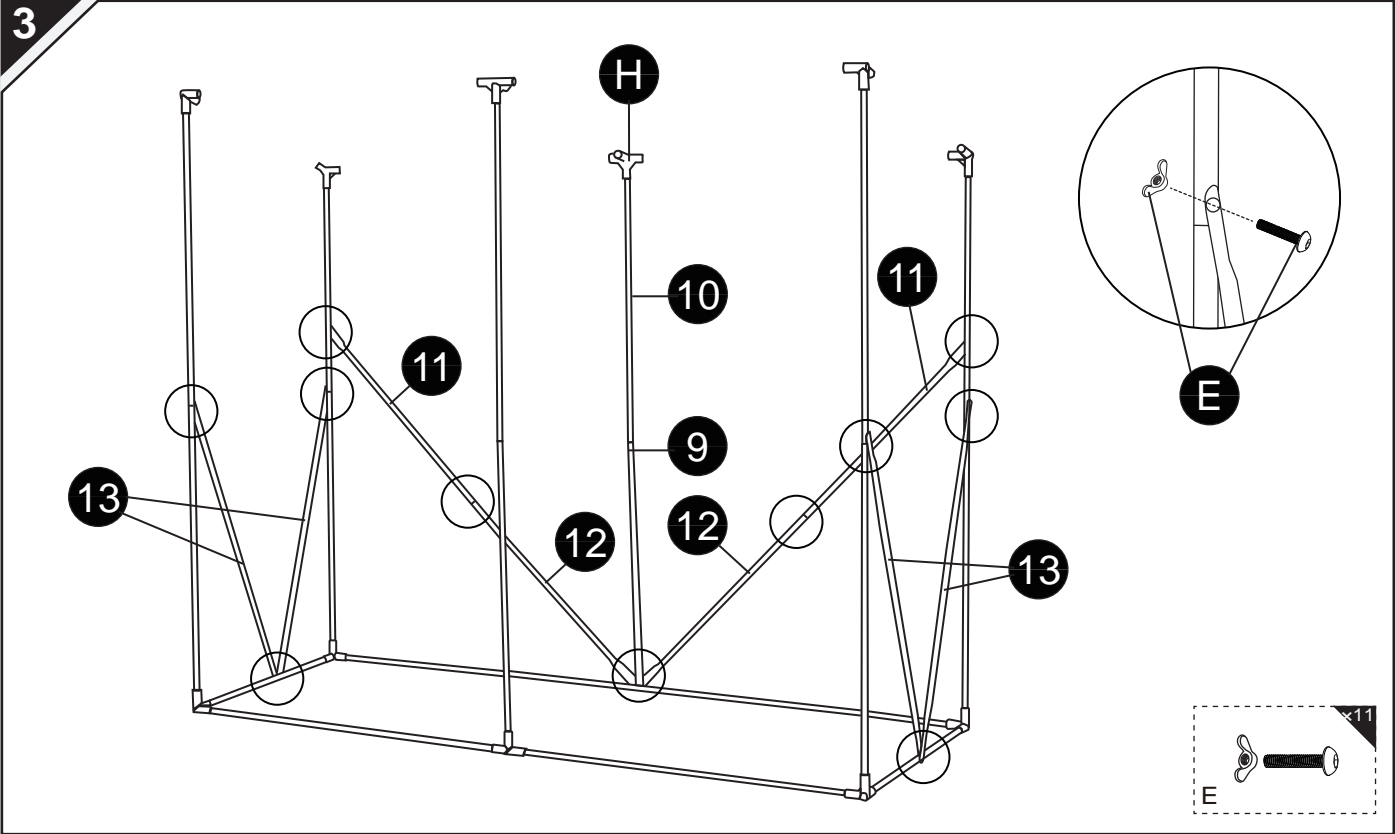

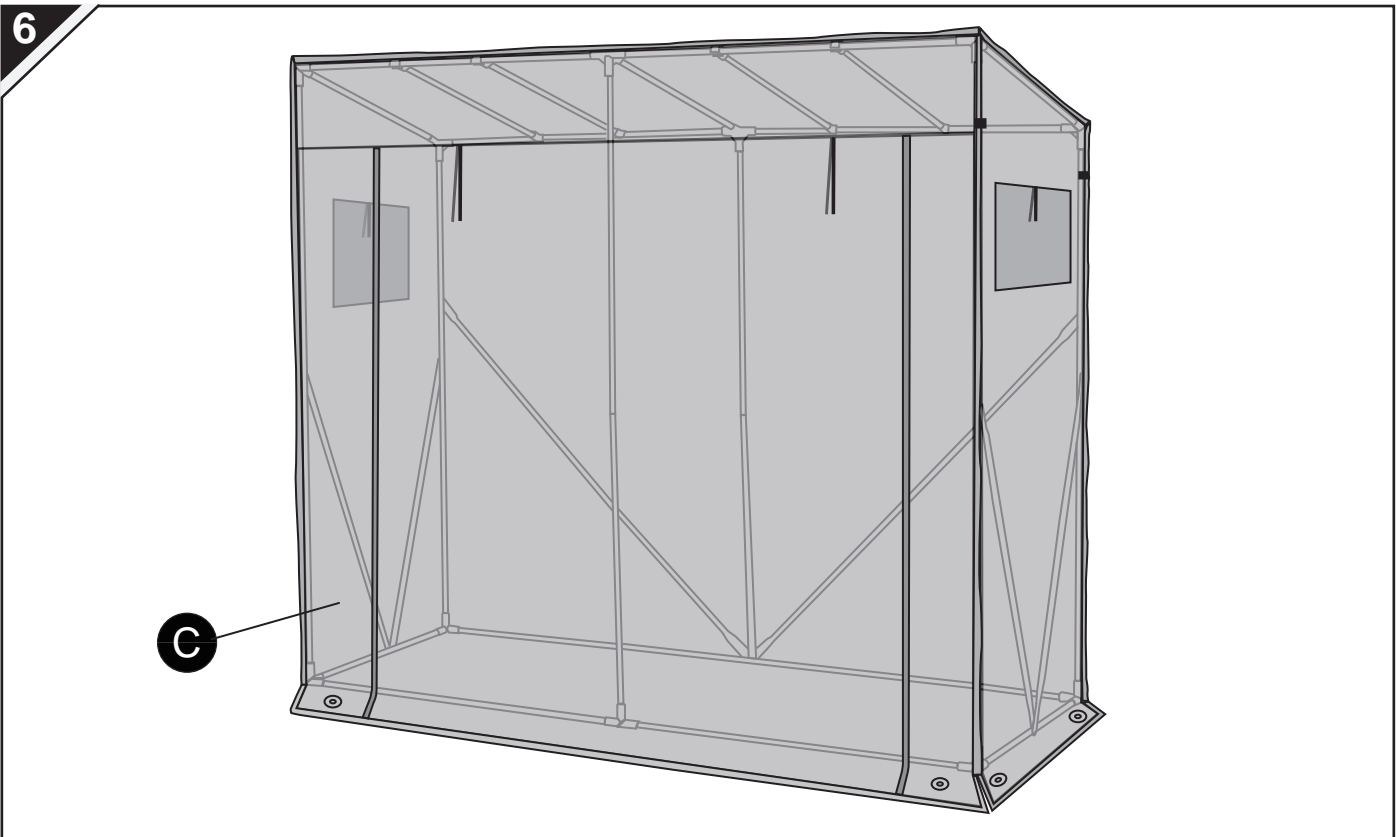
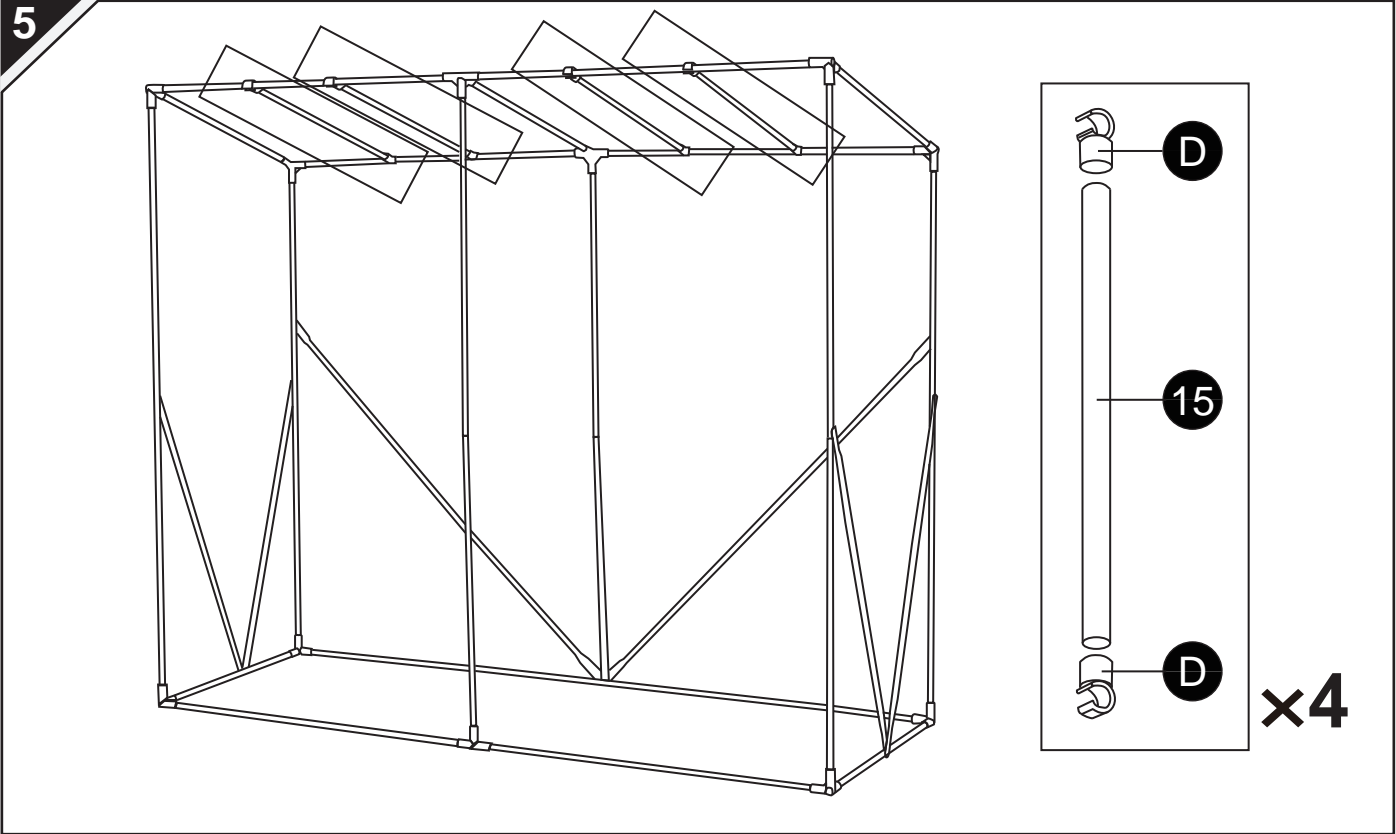

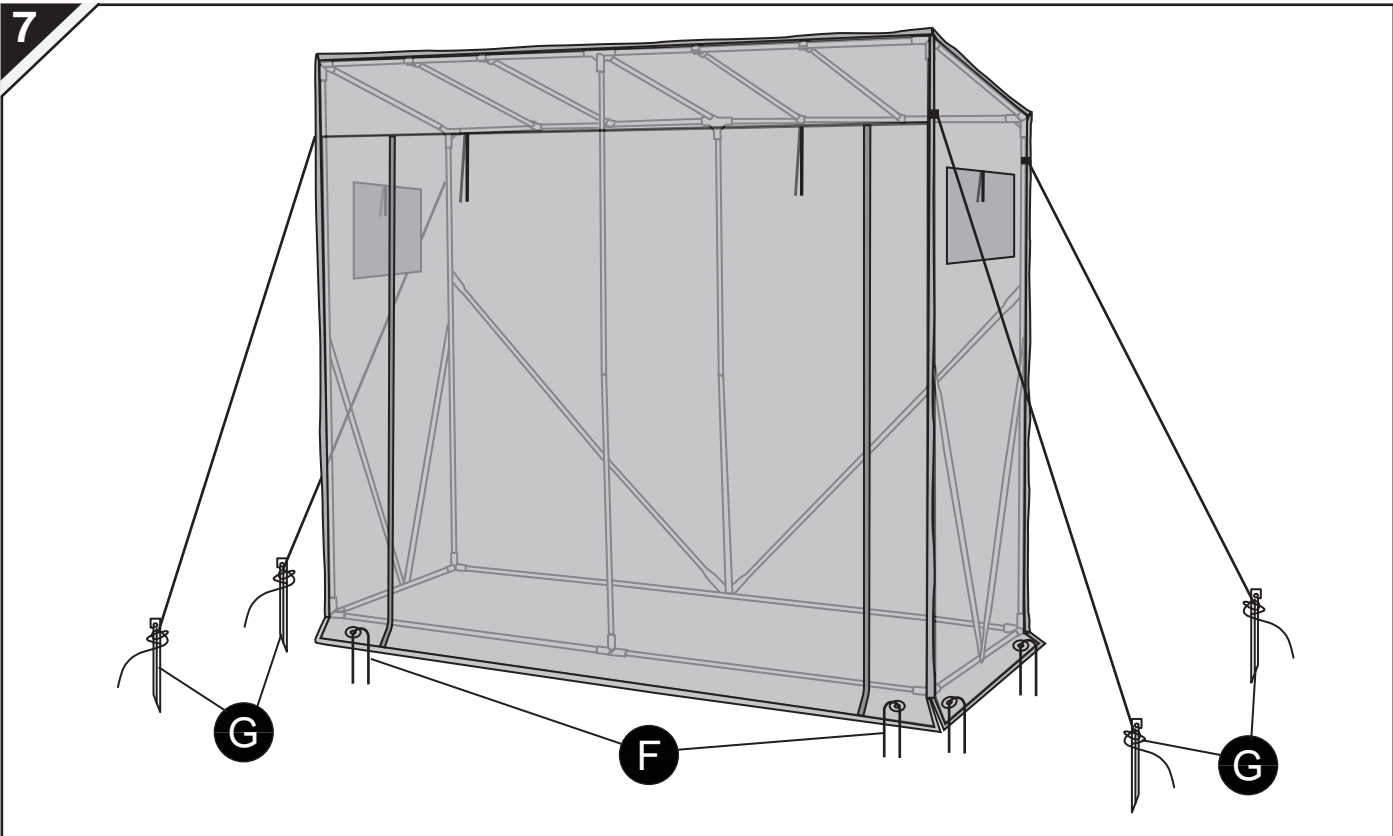

Contact person  
tectake Ltd.  
Mappin House  
4 Winsley Street  
W1W 8HF London ,UK  
Telephone: +44 203488 4565  
www.tectake.co.uk  
mail@tectake.co.uk

Ansprechpartner  
tectake GmbH  
Tauberweg 41  
97999 Igersheim  
Telefon: +49 7931 991 920  
www.tectake.de  
E-Mail: verkauf@tectake.de

Personne de contact  
Made4Home SAS  
137 av. Gustave Eiffel  
ZI Rognac Nord  
13340 Rognac (France)  
téléphone au: +33 4 42 81 81 80  
www.tectake.fr  
E-Mail: contact@tectake.fr

Persona de contacto  
Ibérica de Distribuciones online del Hogar,  
SLU,  
Méndez Álvaro 20,  
Madrid 28045,  
Teléfono: +34 912907933  
www.tectake.es  
correo electrónico: mail@idoh.es

Persona di contatto  
tenulodi S.r.l.  
Via Manzano 70  
33040 Premariacco (UD)  
Numero di telefono: +39 0471 1800175  
www.tectake.it  
E-Mail: mail@tectake.it

Kontaktní osoba  
TecTake s.r.o.  
se sídlem na adrese Lidická 700 / 19, Veverčí,  
602 00 Brno, Česká republika  
+420 538 880 441  
www.tectake.cz  
E-Mail: mail@tectake.cz