

DOM414-1 190x190
DOM415-1 190x250
DOM447-1 190x300

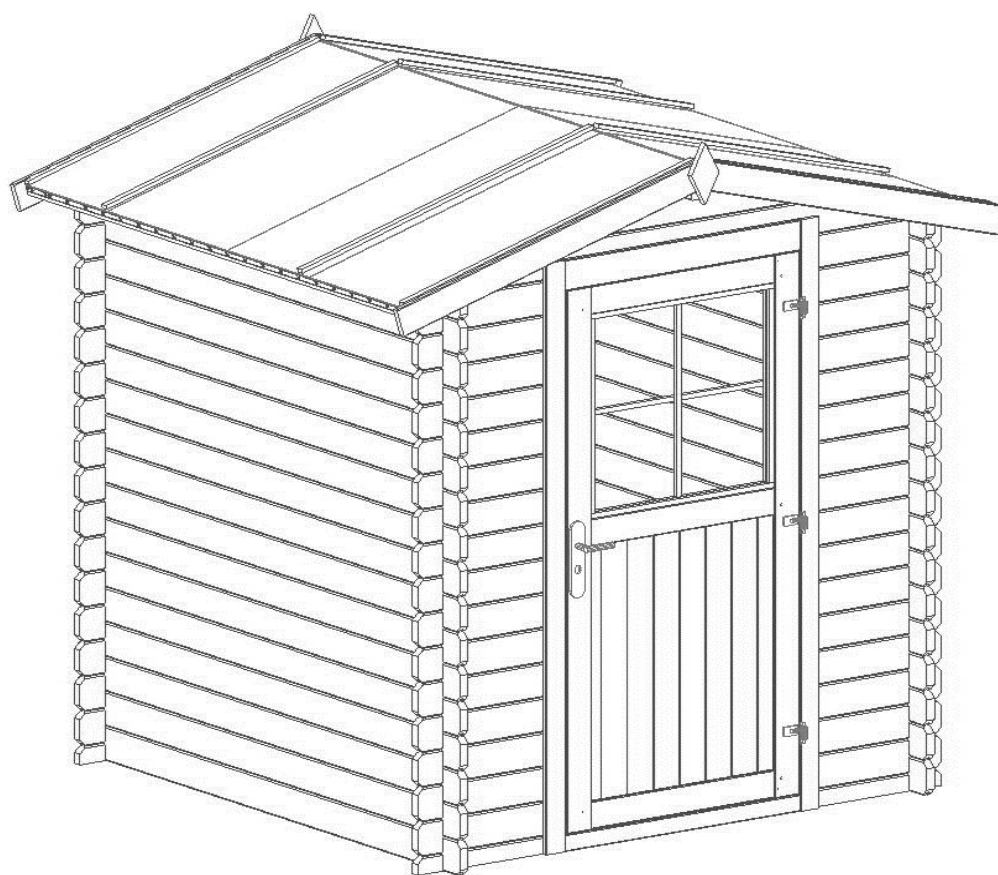

STEP N° 1

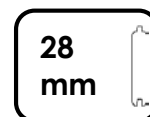
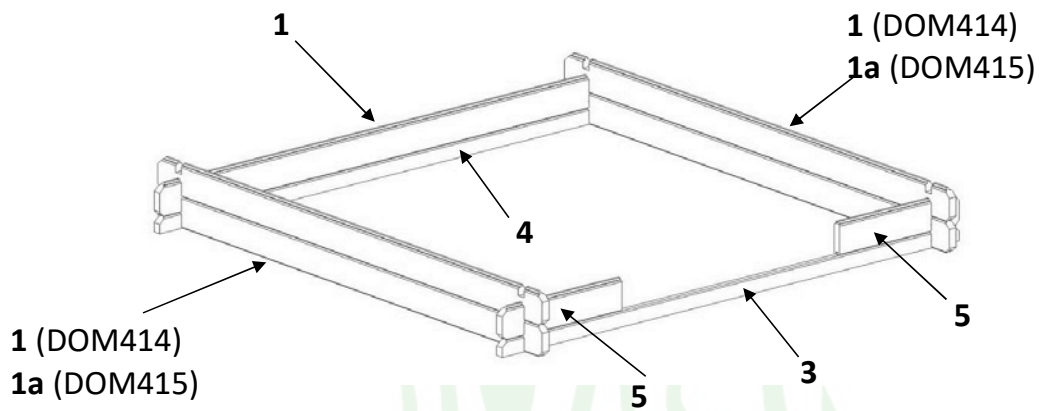

STEP N° 2

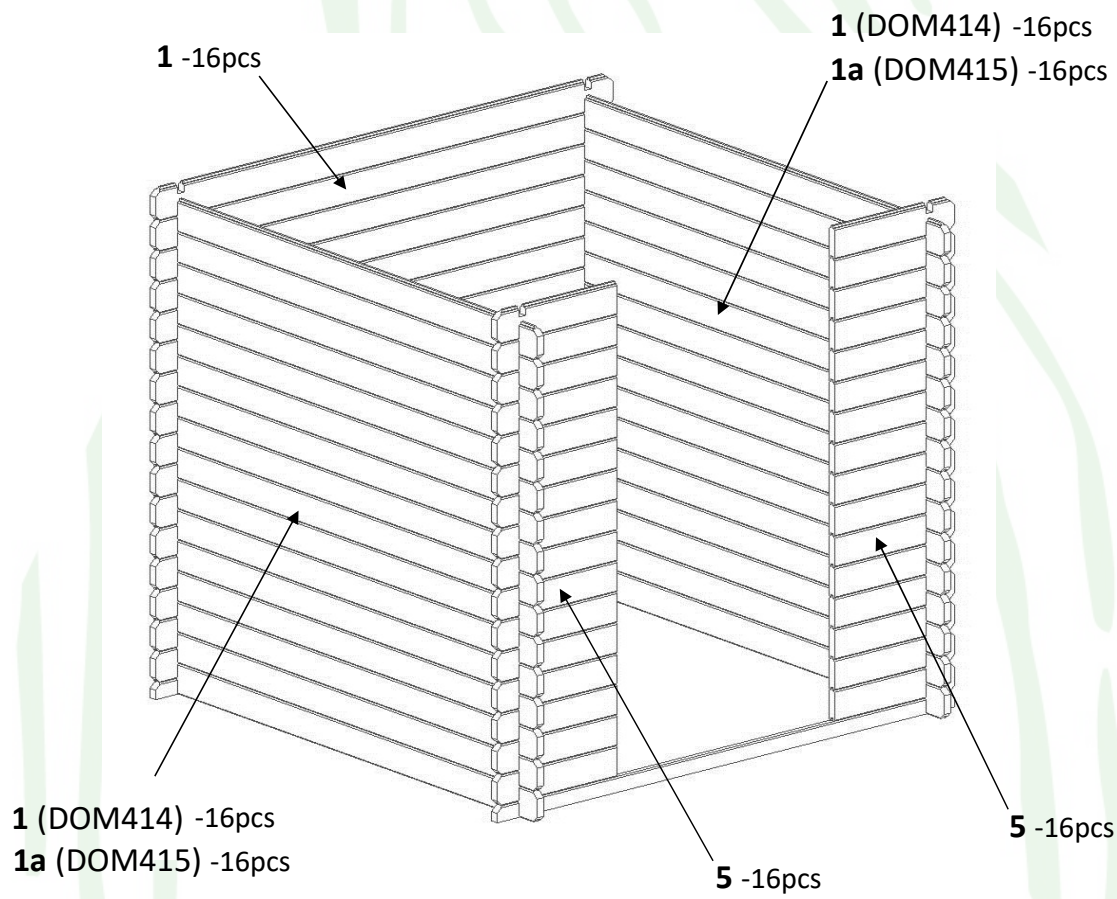

STEP N° 3

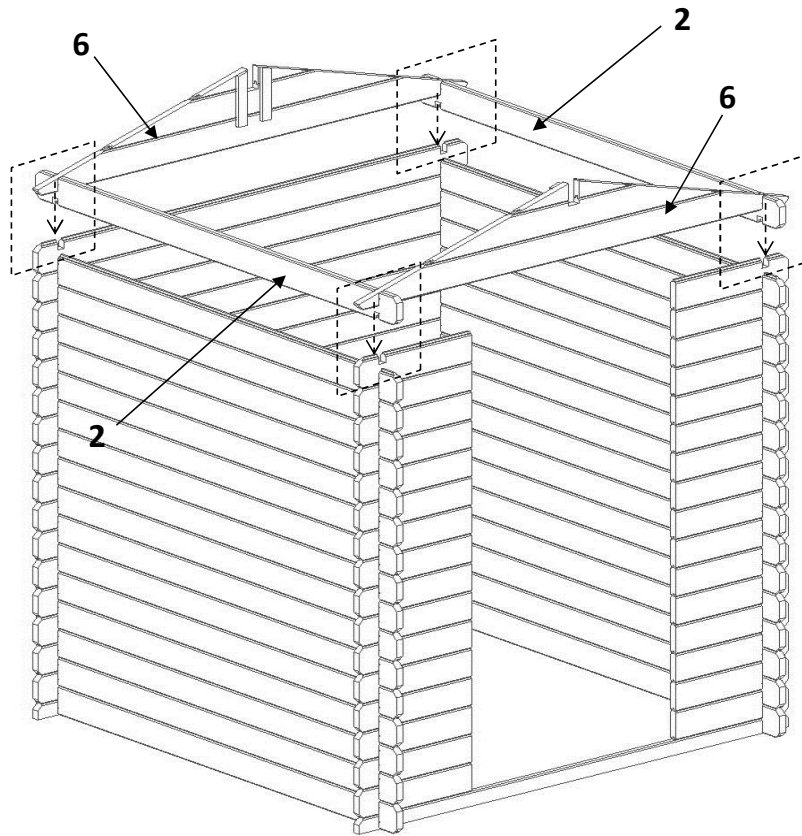

STEP N° 4

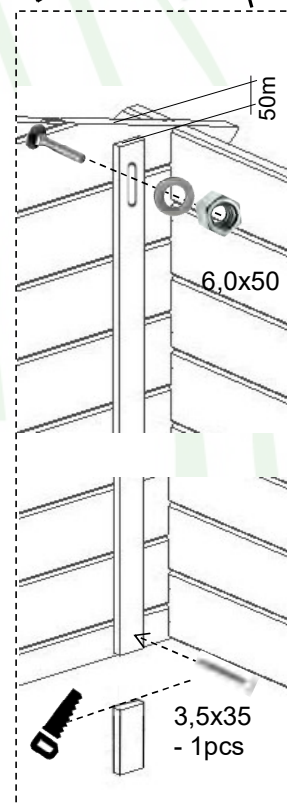
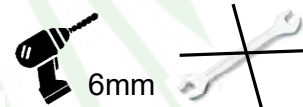
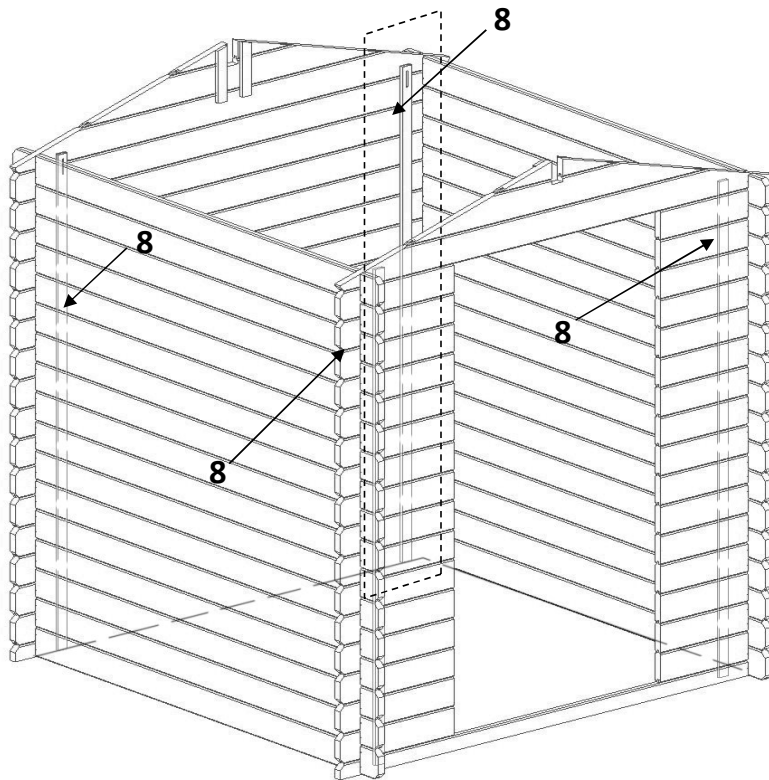

STEP N° 5

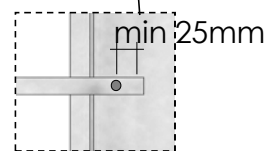
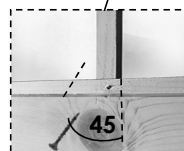
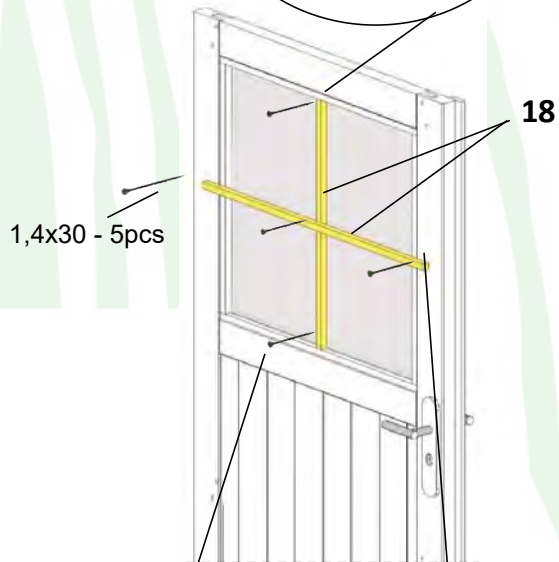
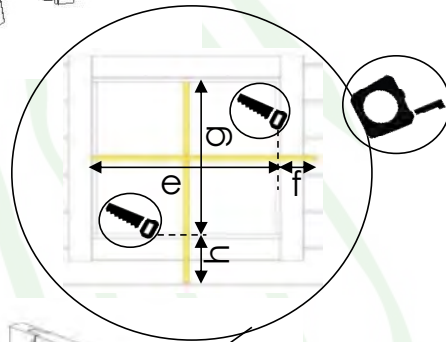
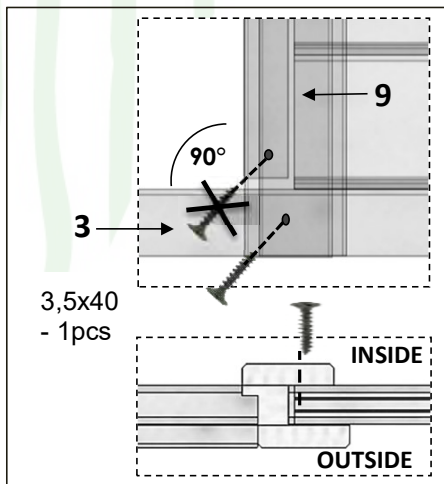
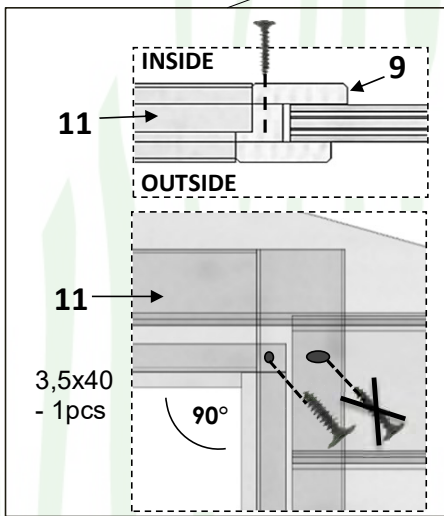
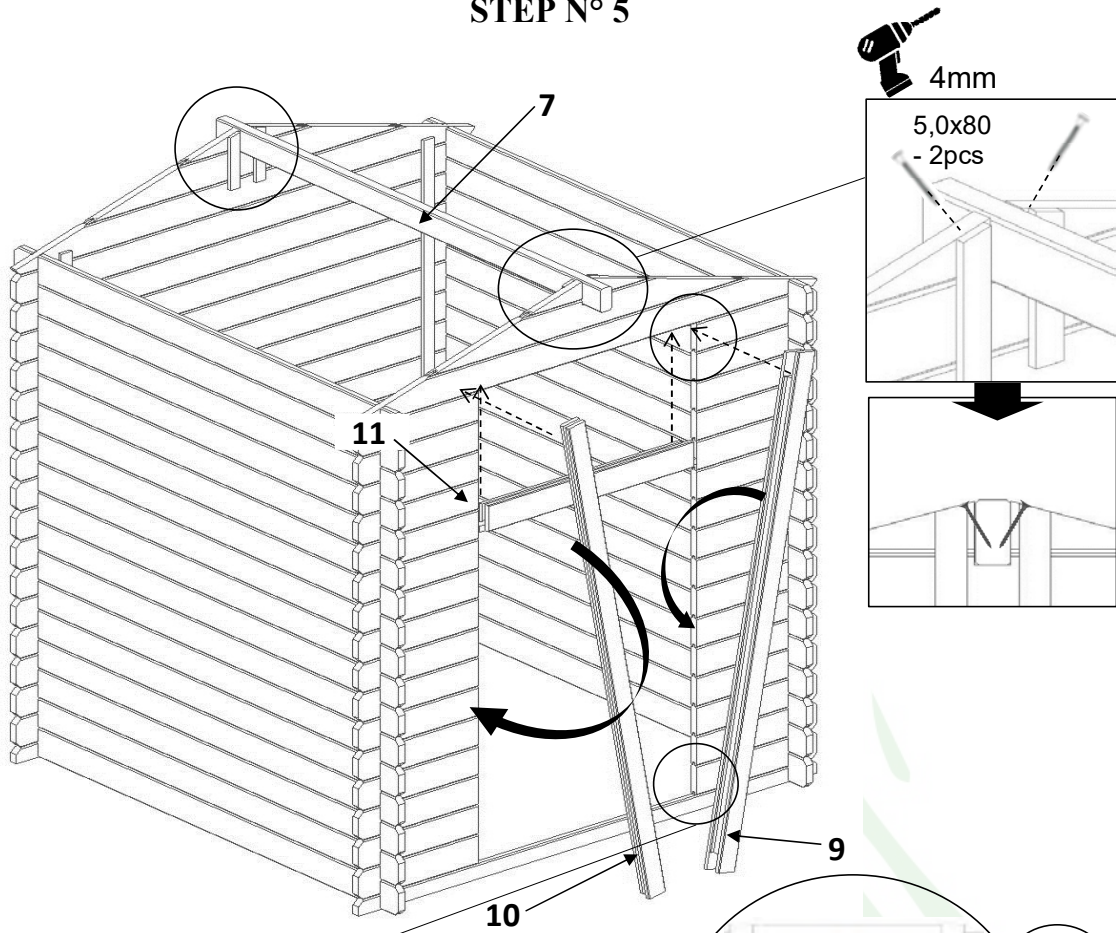

STEP N° 6

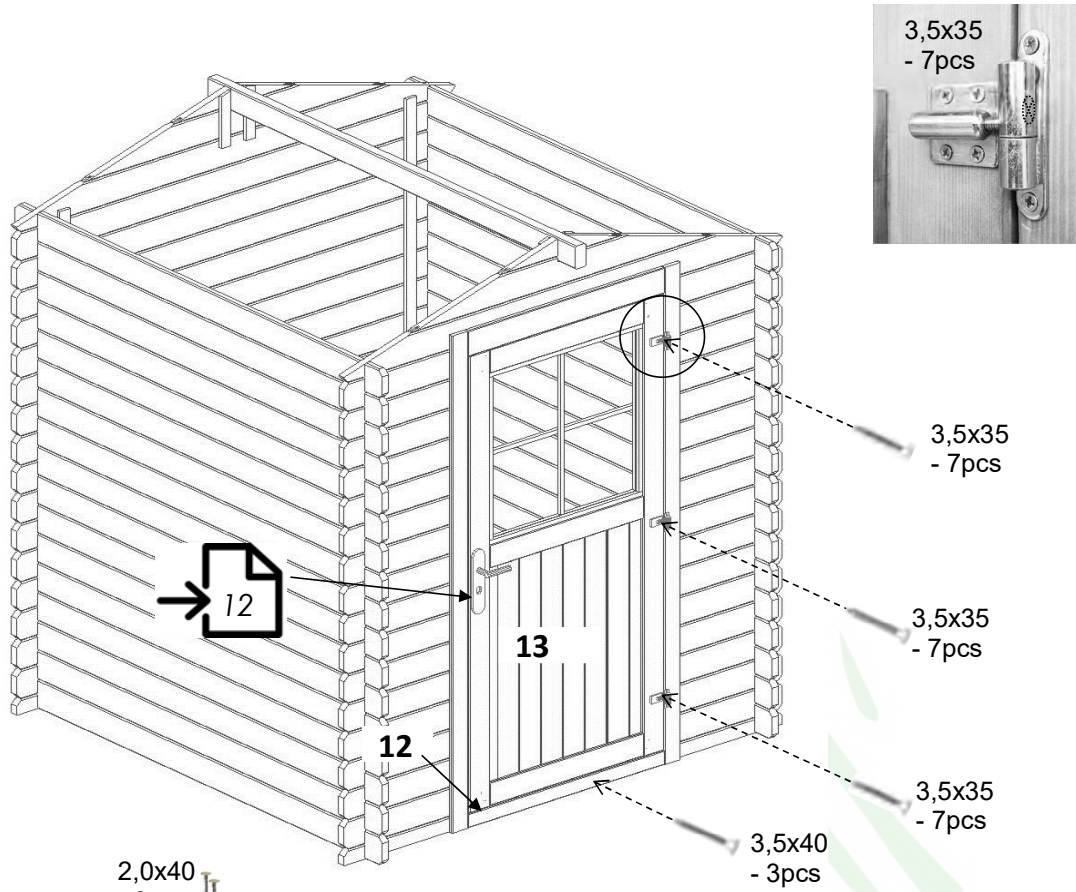

STEP N° 7

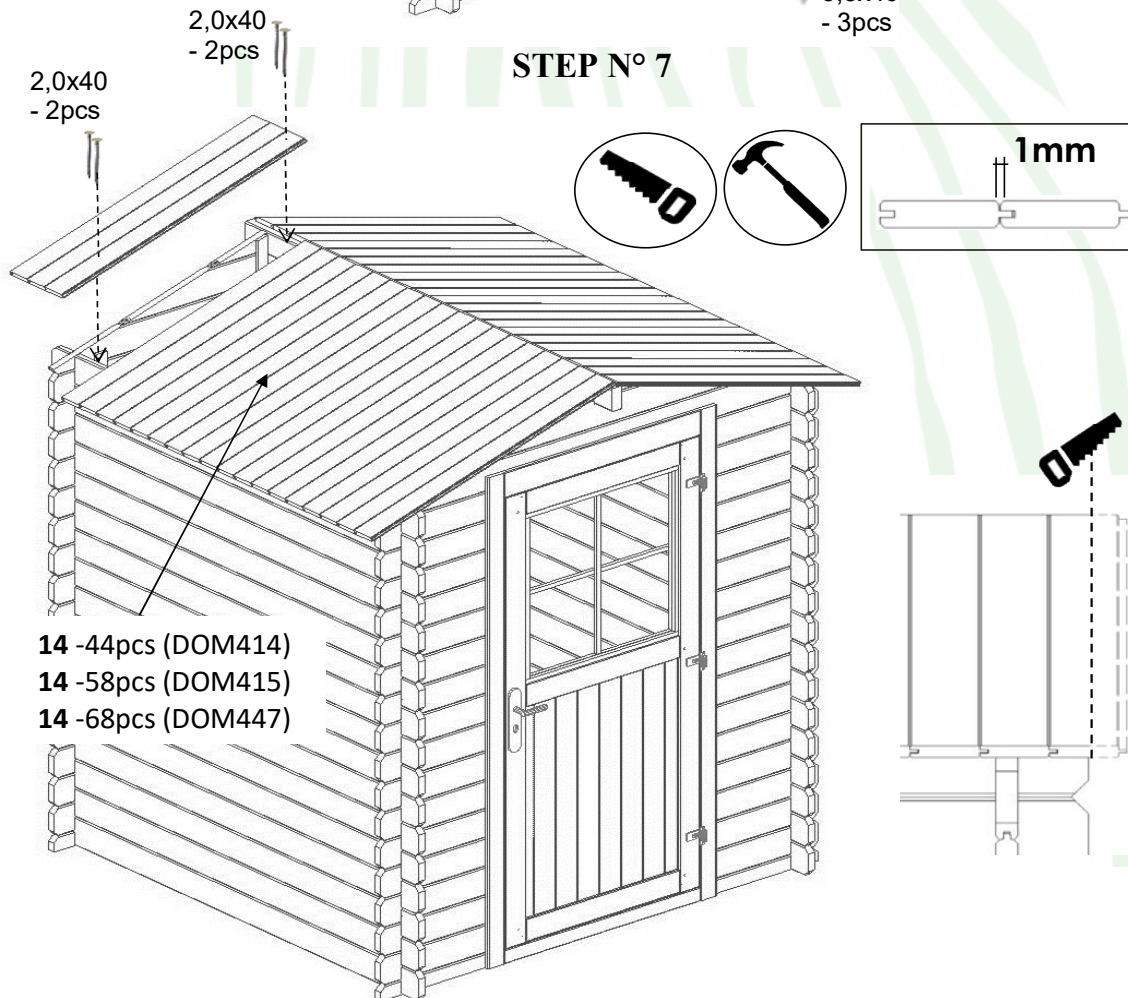

STEP N° 8

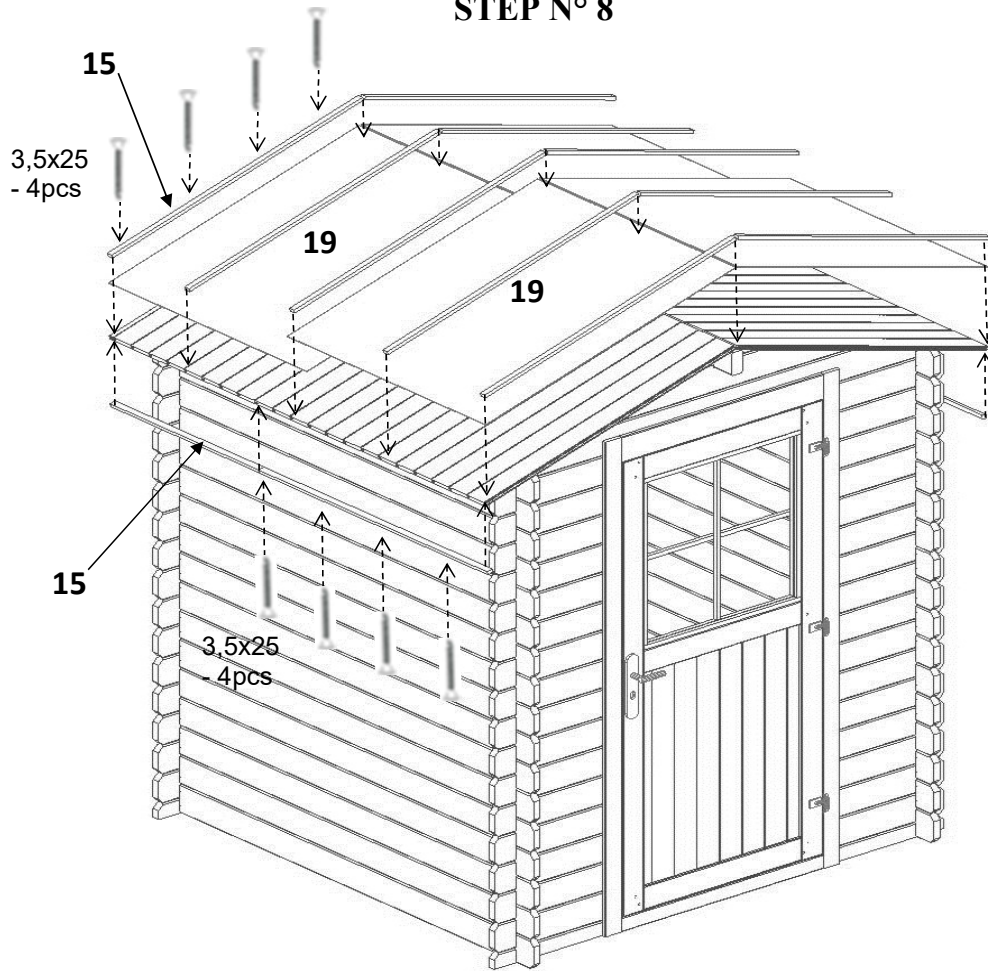

STEP N° 9

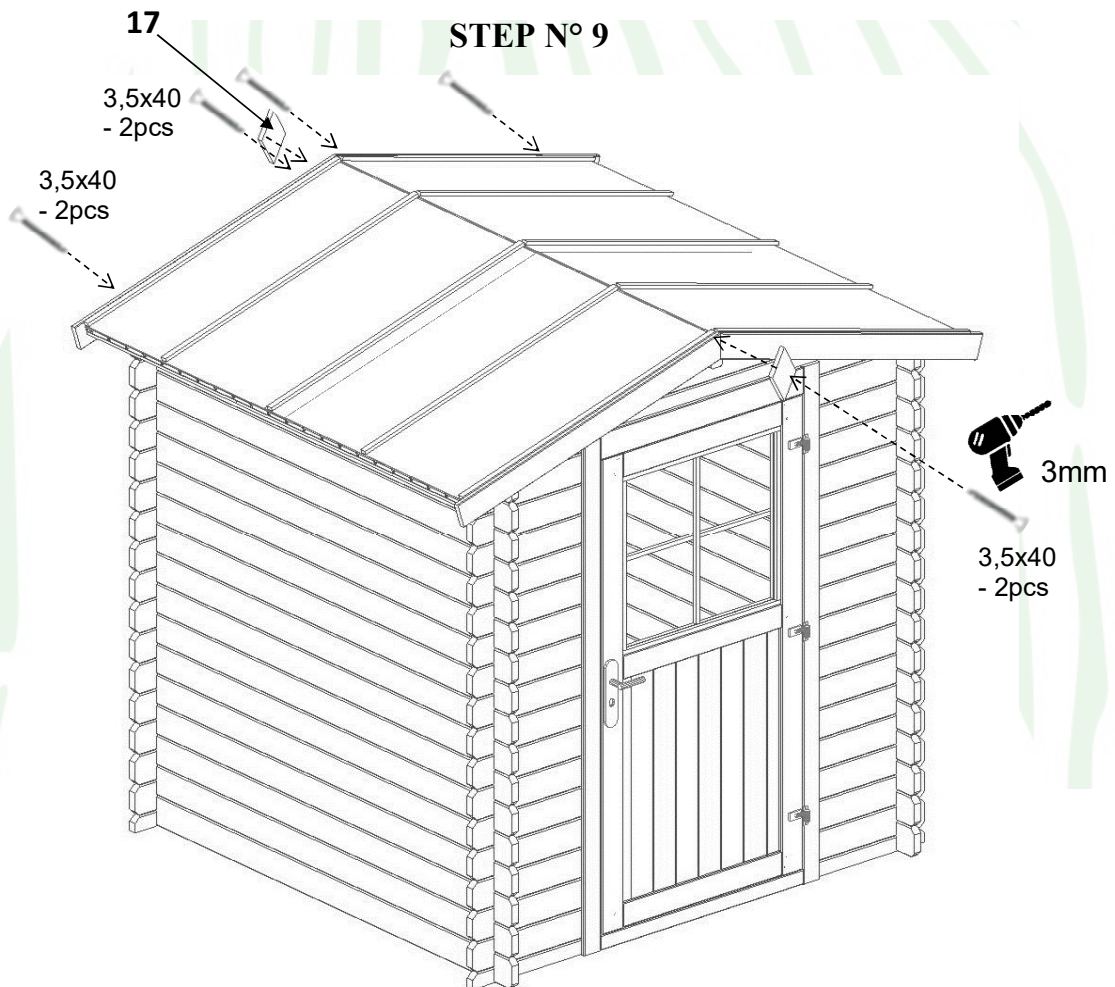

DOM 414-1

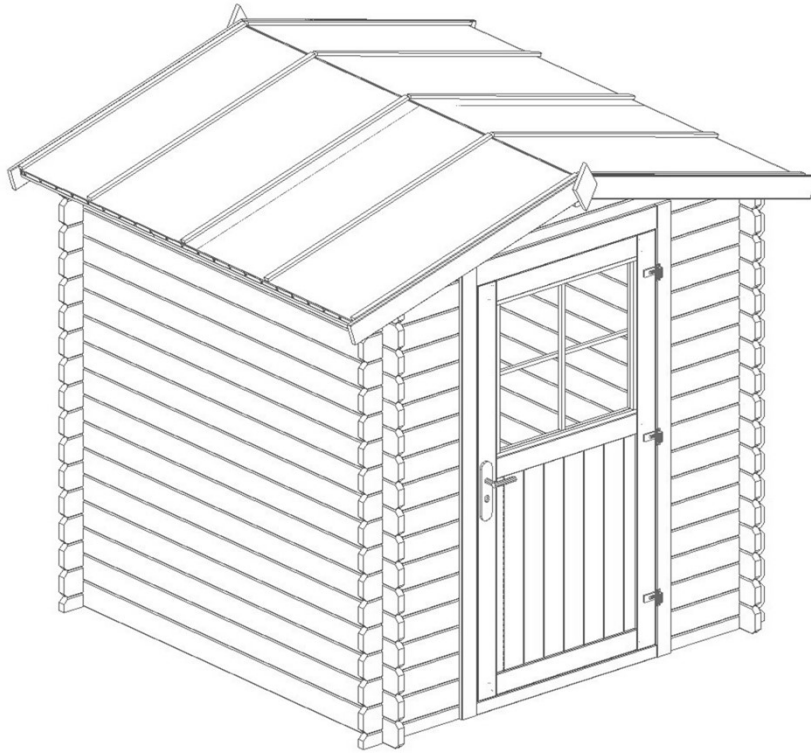



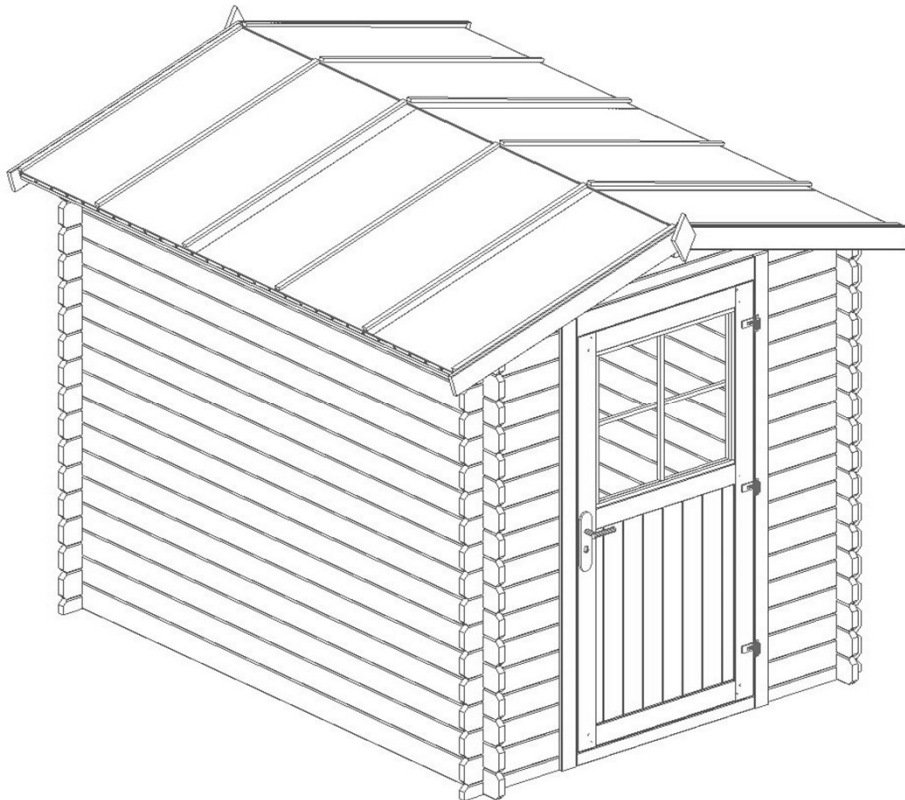



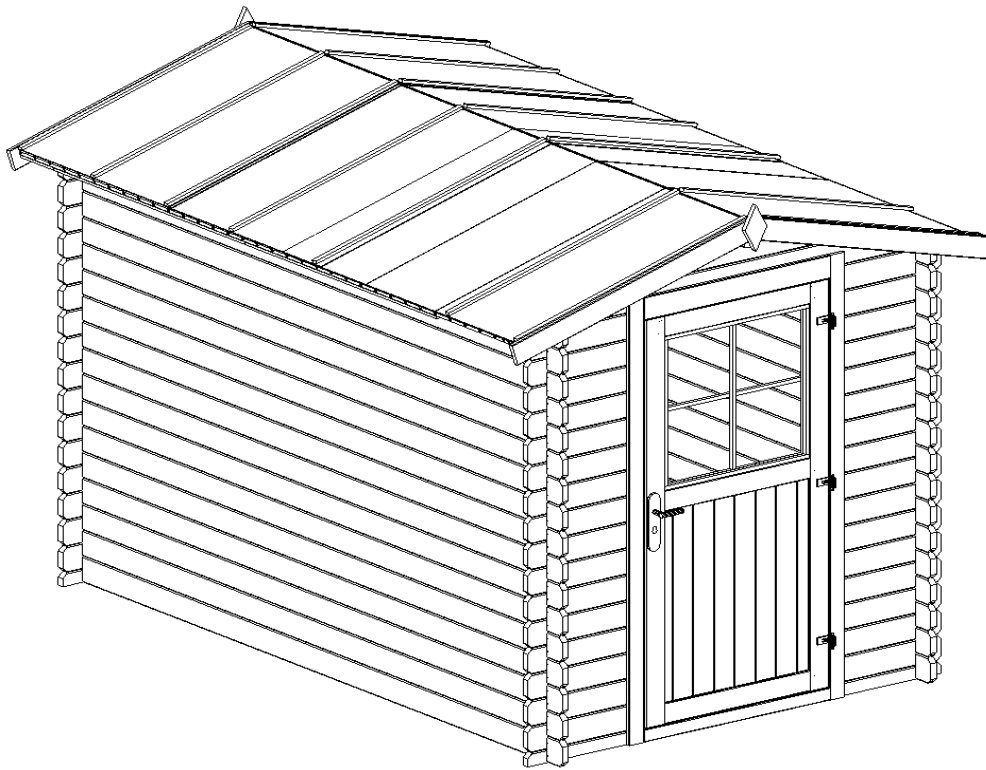







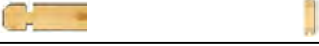



DOM 415-1













DOM 447-1

















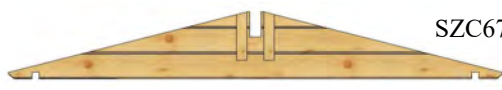





DOM414-1 190x190 28mm



Ref	Designation	Dimension			Quantity
1		1900	121	28	48
2		1900	113	28	2
3		1900	65	28	1
4		1900	65	28	1
5		496	121	28	32
6	 SZC67-1	1900	297	28	2
7		1900	90	45	1
8		2000	45	13	4
9	 OSCP01	1926	82	61	1
10	 OSCL02	1926	82	61	1
11	 NAD02	898	112	61	1
12	 PRO02	852	55	16	1
13	 DRZ30-10	1765	845	38	1
14		1100	99	16	44
15		1150	22	13	16
16		1150	95	16	4
17		165	110	19	2
18		16	16	1000	3
19		2500	1000	2	2

Ref	Designation	Dimension	Quantity
1		3,5x25	65
2		3,5x35	25
3		3,5x40	27
4		5,0x80	4
5		6x50	4
6		2x40	176
7			3
8			1
9		1,4x30	5
10			1





















DOM415-1 190x250 28mm

Ref	Designation	Dimension			Quantity
1		1900	121	28	16
1a		2500	121	28	32
2		2500	113	28	2
3		1900	65	28	1
4		1900	65	28	1
5		496	121	28	32
6	 SZC67-1	1900	297	28	2
7		2500	90	45	1
8		2000	45	13	4
9	 OSCP01	1926	82	61	1
10	 OSCL02	1926	82	61	1
11	 NAD02	898	112	61	1
12	 PRO02	852	55	16	1
13	 DRZ30-10	1765	845	38	1
14		1100	99	16	58
15		1150	22	13	18
16		1150	95	16	4
17		165	110	19	2
18		16	16	1000	3
19		2500	1000	2	3



Ref	Designation	Dimension	Quantity
1		3,5x25	81
2		3,5x35	25
3		3,5x40	27
4		5,0x80	4
5		6x50	4
6		2x40	232
7			3
8			1

9		1,4x30	5
10			1

DOM447-1 190x300 28mm

Ref	Designation	Dimension			Quantity
1		1900	121	28	16
1a		3000	121	28	32
2		3000	113	28	2
3		1900	65	28	1
4		1900	65	28	1
5		496	121	28	32
6	 SZC67-1	1900	297	28	2
7		3000	90	45	1
8		2000	45	13	4
9	 OSCP01	1926	82	61	1
10	 OSCL02	1926	82	61	1
11	 NAD02	898	112	61	1
12	 PRO02	852	55	16	1
13	 DRZ30-10	1765	845	38	1
14		1100	99	16	68
15		1150	22	13	22
16		1150	95	19	4
17		165	110	19	2
18		16	16	1000	3
19		2500	1000	2	4

Ref	Designation	Dimension	Quantity
1		3,5x25	97
2		3,5x35	25
3		3,5x40	27
4		5,0x80	4
5		6x50	4
6		2x40	272
7			3

8			1
9		1,4x30	5
10			1

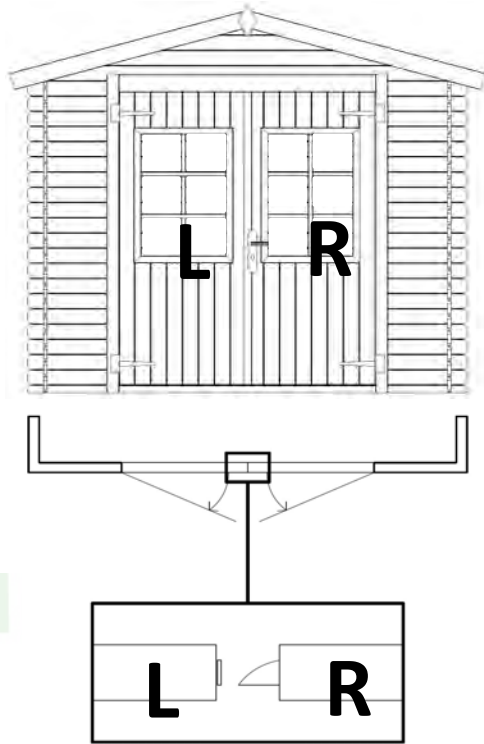
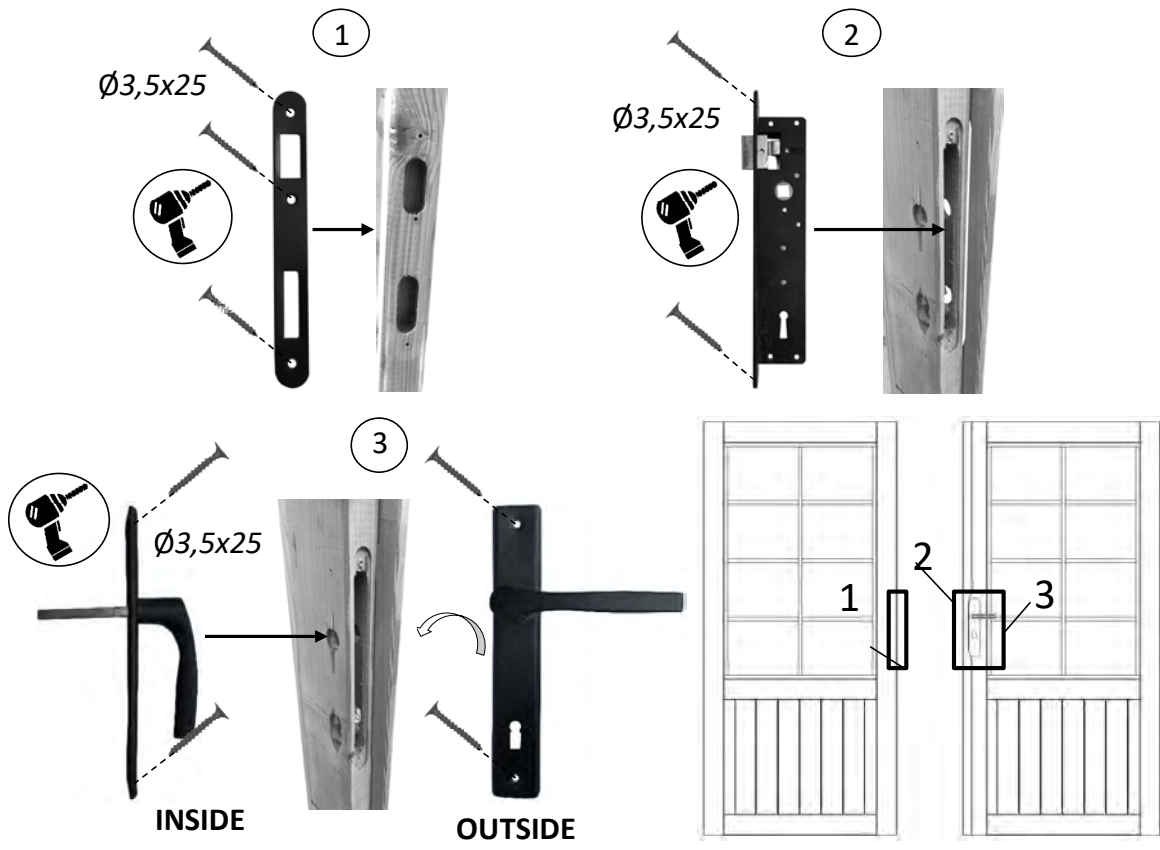

lock - change from the left to the right

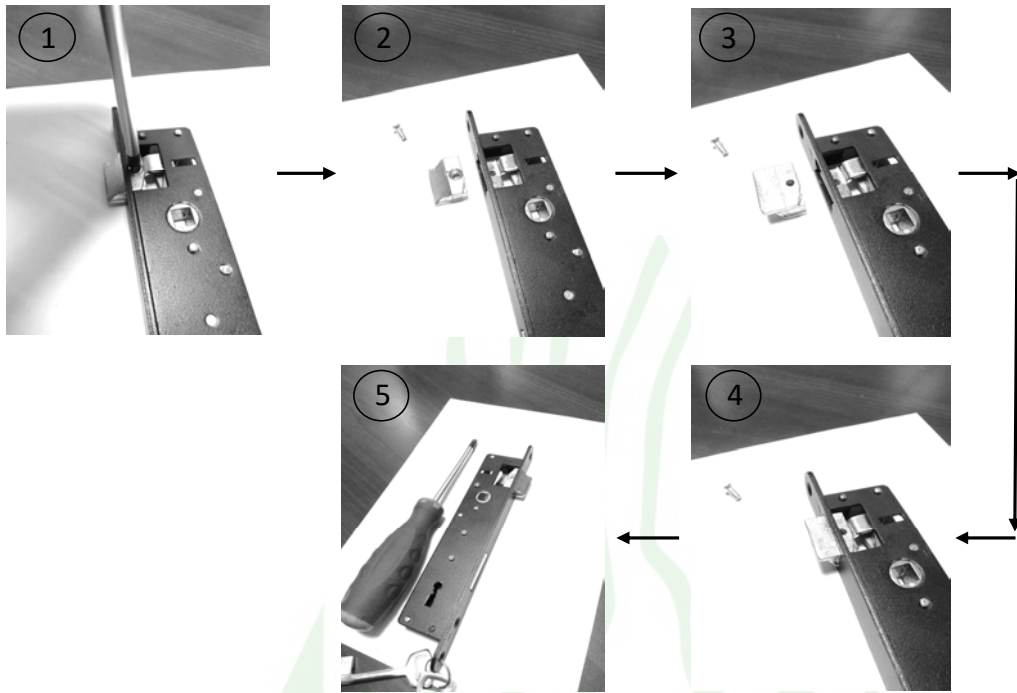

lock - change from the right to the left

