

Lena

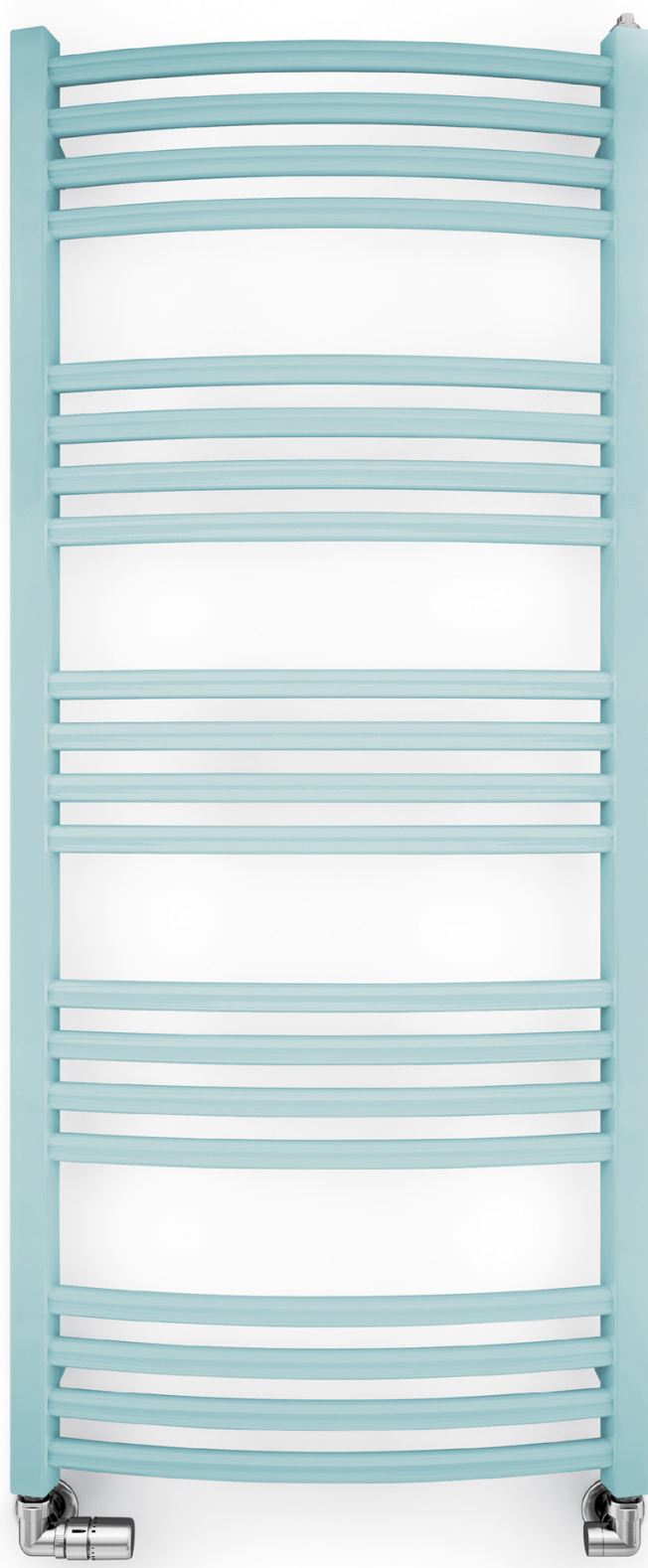

COULEUR
AU CHOIX



Lena

Raccordements

Chauffage central



Électrique



Mixte



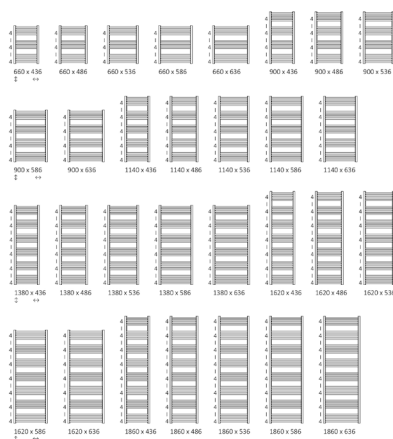

Dimensions disponibles



Lena

Données techniques

Pression du travail : 1,0 MPa Température maximale de travail : 95°C

A ↓	B ↔	C2 [mm]	75 65 20°C [W]	55 45 20°C [W]	 [W]	D [mm]	E [mm]	F [mm]	 [dm³]	 [kg]
660	436	400	262	141	300	392	475	94	2,36	4,70
660	486	450	287	155	300	442	475	94	2,54	5,08
660	536	500	312	168	300	492	475	94	2,72	5,47
660	586	550	337	181	400	542	475	94	2,90	5,85
660	636	600	361	194	400	592	475	94	3,08	6,23
900	436	400	351	189	400	392	715	94	3,18	6,29
900	486	450	385	207	400	442	715	94	3,42	6,80
900	536	500	418	225	400	492	715	94	3,65	7,32
900	586	550	451	242	400	542	715	94	3,89	7,83
900	636	600	484	260	600	592	715	94	4,13	8,34
1140	436	400	440	236	400	392	955	94	3,99	7,89
1140	486	450	483	259	600	442	955	94	4,29	8,53
1140	536	500	525	281	600	492	955	94	4,59	9,17
1140	586	550	566	303	600	542	955	94	4,89	9,81
1140	636	600	607	325	600	592	955	94	5,19	10,45
1380	436	400	530	284	600	392	1195	94	4,81	9,48
1380	486	450	582	311	600	442	1195	94	5,17	10,25
1380	536	500	632	338	600	492	1195	94	5,53	11,02
1380	586	550	682	365	800	542	1195	94	5,88	11,79
1380	636	600	731	391	800	592	1195	94	6,24	12,56
1620	436	400	621	332	600	392	1435	94	5,63	11,08
1620	486	450	681	364	800	442	1435	94	6,04	11,97
1620	536	500	741	396	800	492	1435	94	6,46	12,87
1620	586	550	799	427	800	542	1435	94	6,88	13,77
1620	636	600	857	457	800	592	1435	94	7,30	14,66
1860	436	400	714	380	800	392	1675	94	6,44	12,67
1860	486	450	783	417	800	442	1675	94	6,92	13,70
1860	536	500	851	453	800	492	1675	94	7,40	14,72
1860	586	550	918	489	1000	542	1675	94	7,87	15,75
1860	636	600	984	524	1000	592	1675	94	8,35	16,77

Lena

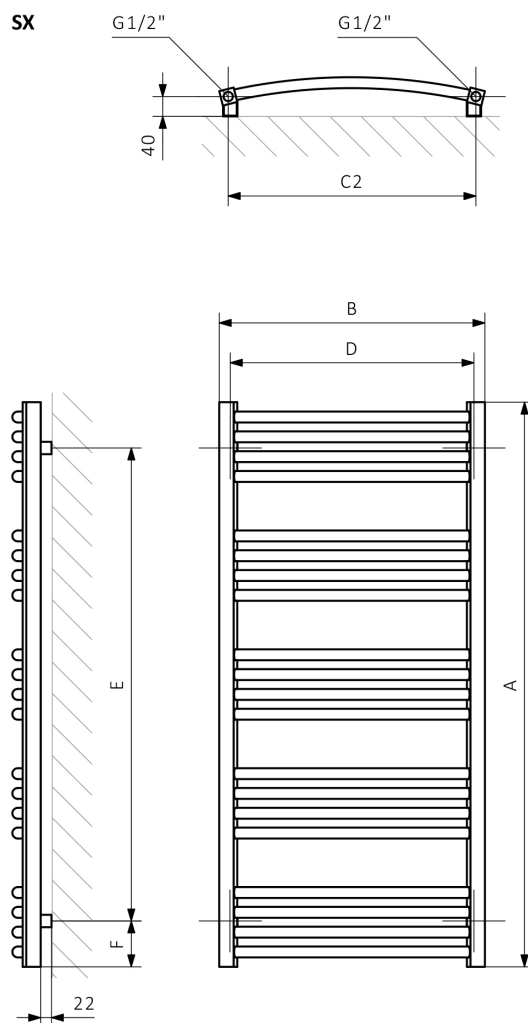

A – hauteur B – largeur C1-C5 – écartement des raccords D – écartement des consoles en horizontal E – écartement des consoles en vertical F – distance de l'axe de la console inférieure au bord inférieur du collecteur

Collecteur :

Profil :

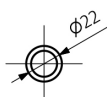
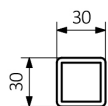

Lena

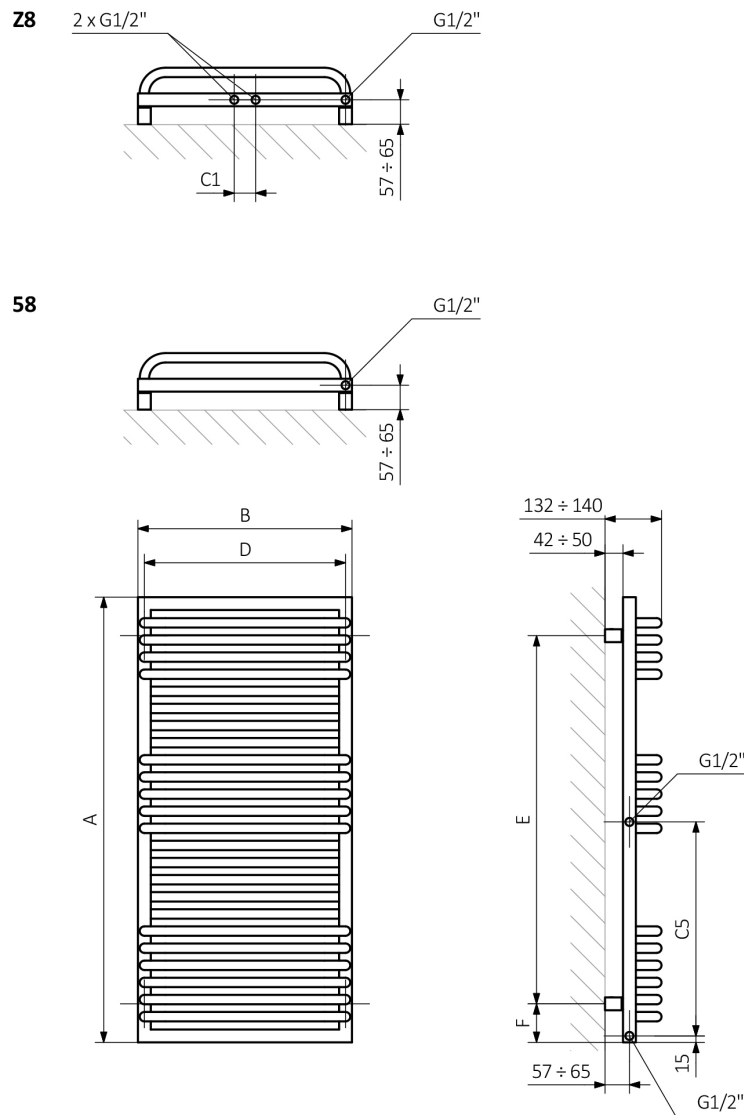

A – hauteur B – largeur C1-C5 – écartement des raccords D – écartement des consoles en horizontal E – écartement des consoles en vertical F – distance de l'axe de la console inférieure au bord inférieur du collecteur

Collecteur :

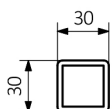

Profil :

