

# Calder 508-5-REV00

REVISIONS				
ZONE	REV.	DESCRIPTION	DATE	APPROVED
	00	AÇIKLAMA	01.01.2011	ONAYLAYAN

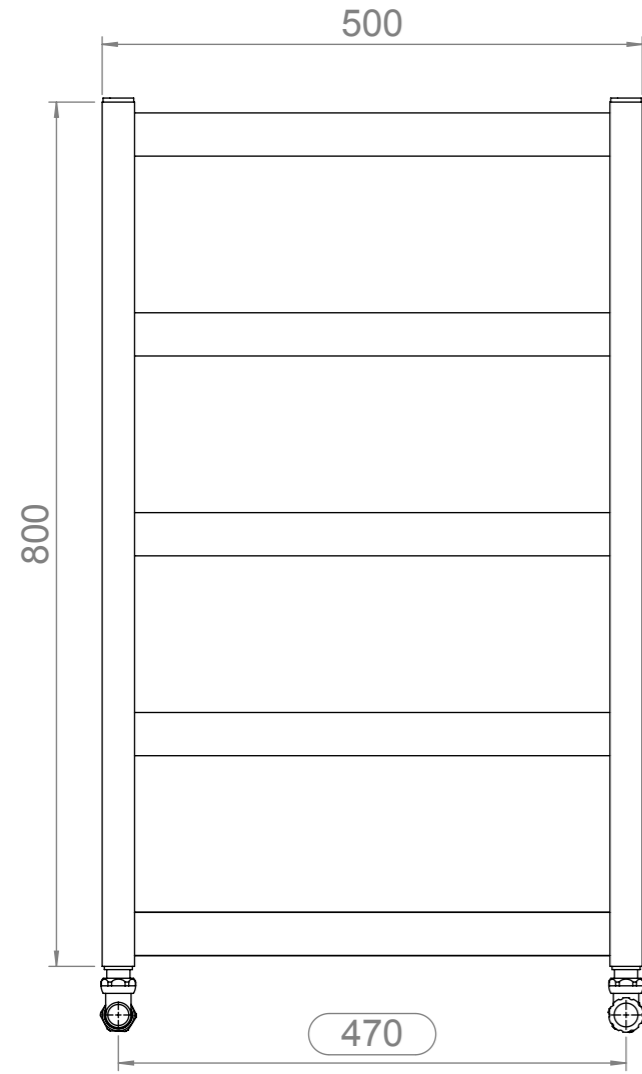

Front View

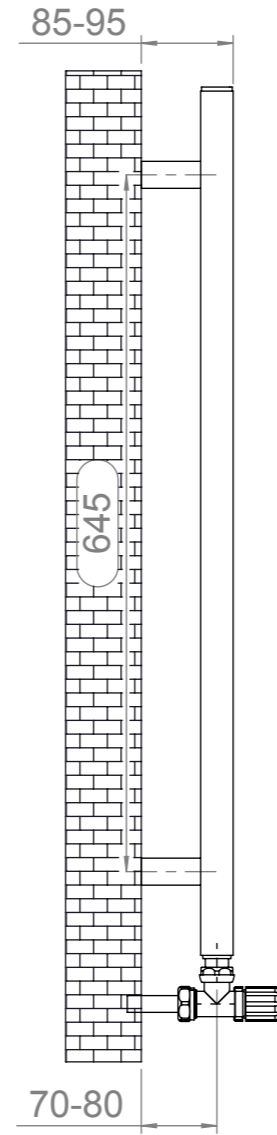

Side View

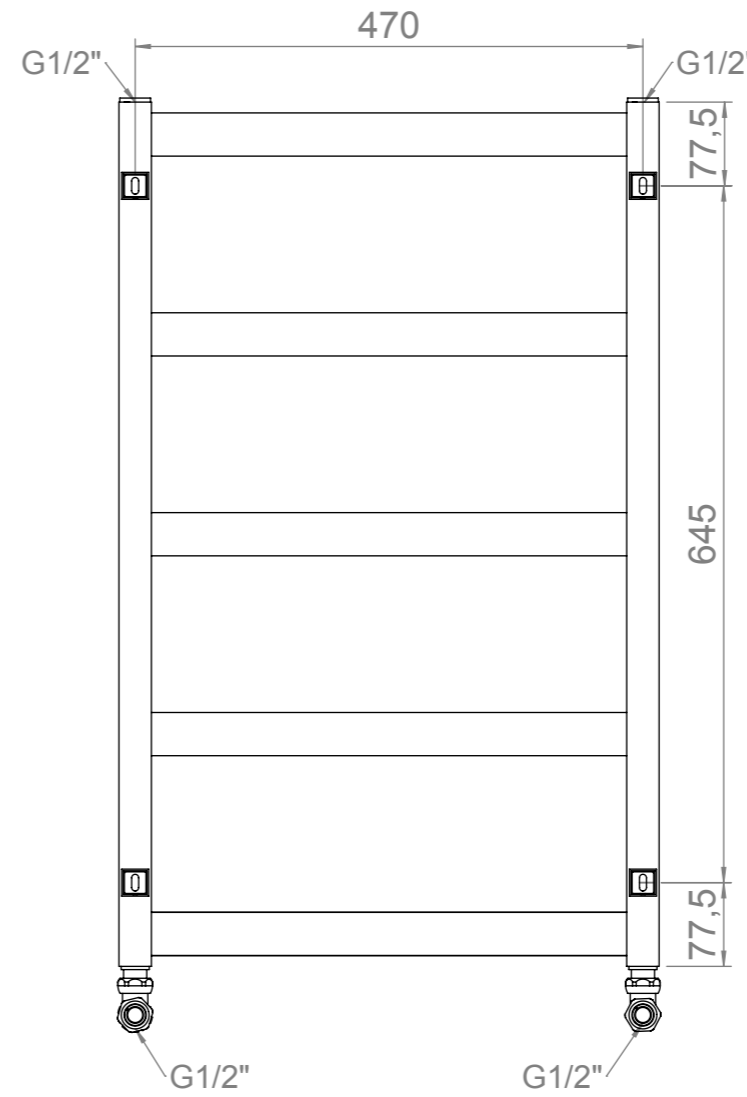

Back View

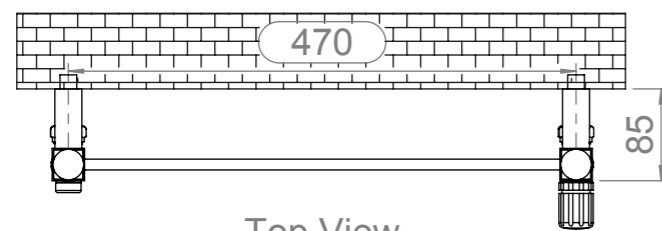
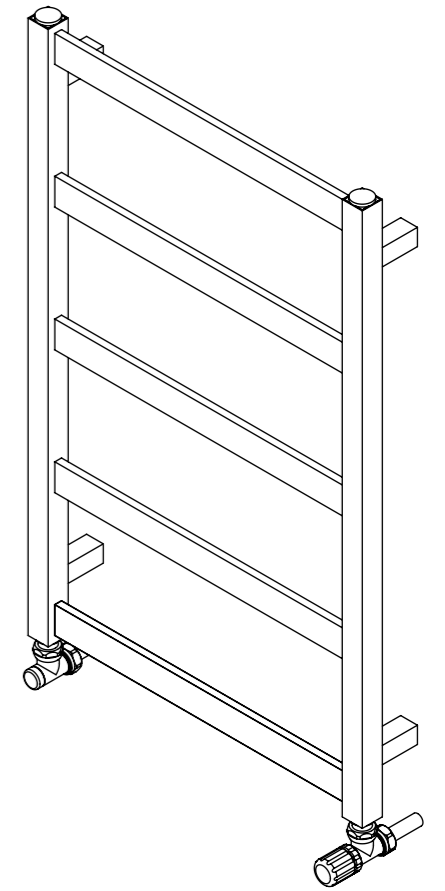

Top View

### Installation Accesories:

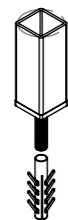
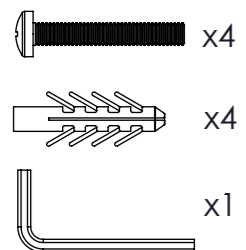

### Fitting Position:

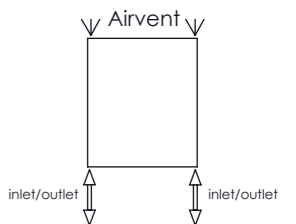

All Dimension are in mm  
 Max.Working Pressure = 10 Bar  
 Max.Working Temperature=95° C  
 Inlet / Outlet : 1/2" BSP