

DOM521-1 250x250 28mm

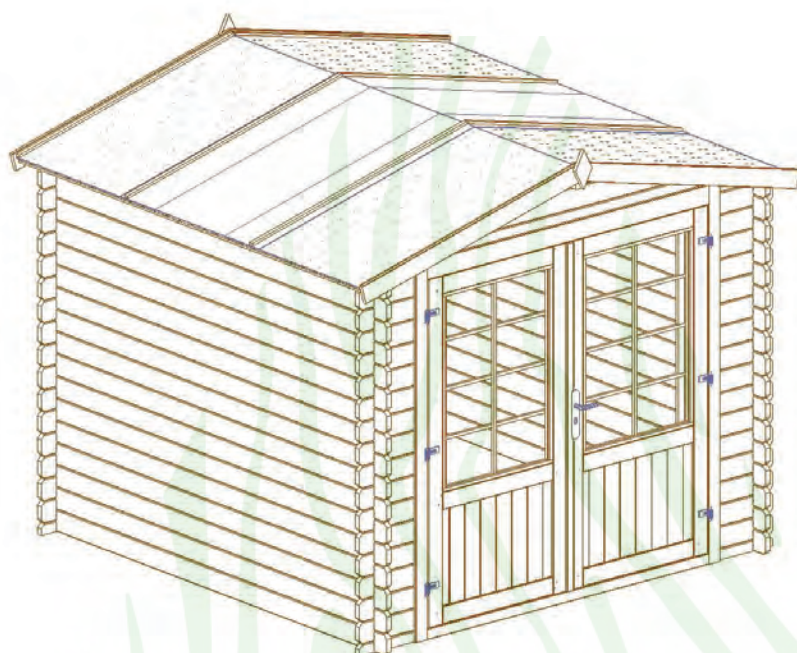

DOM140-4 300x200 28mm

DOM349-2 300x300 28mm

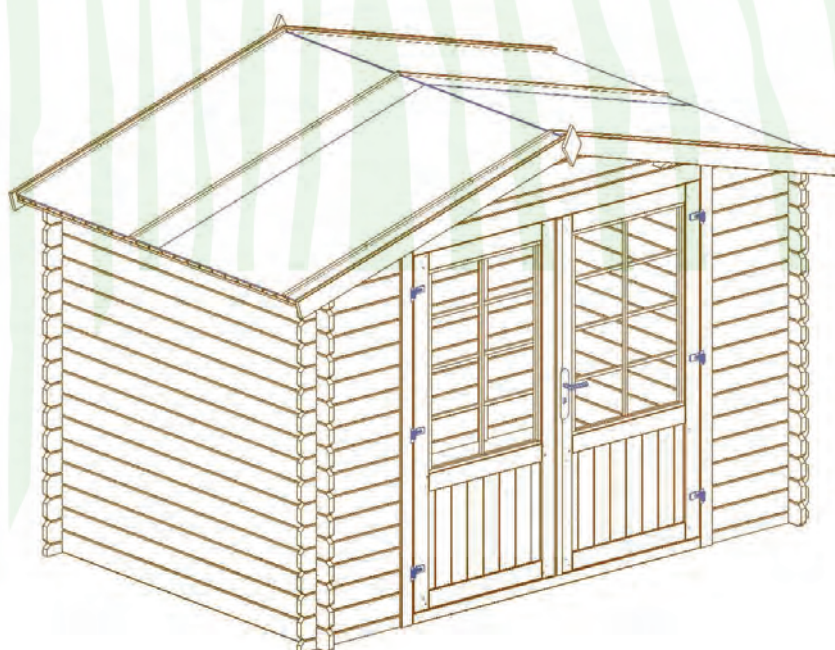

DOM521-1 250x250 28mm

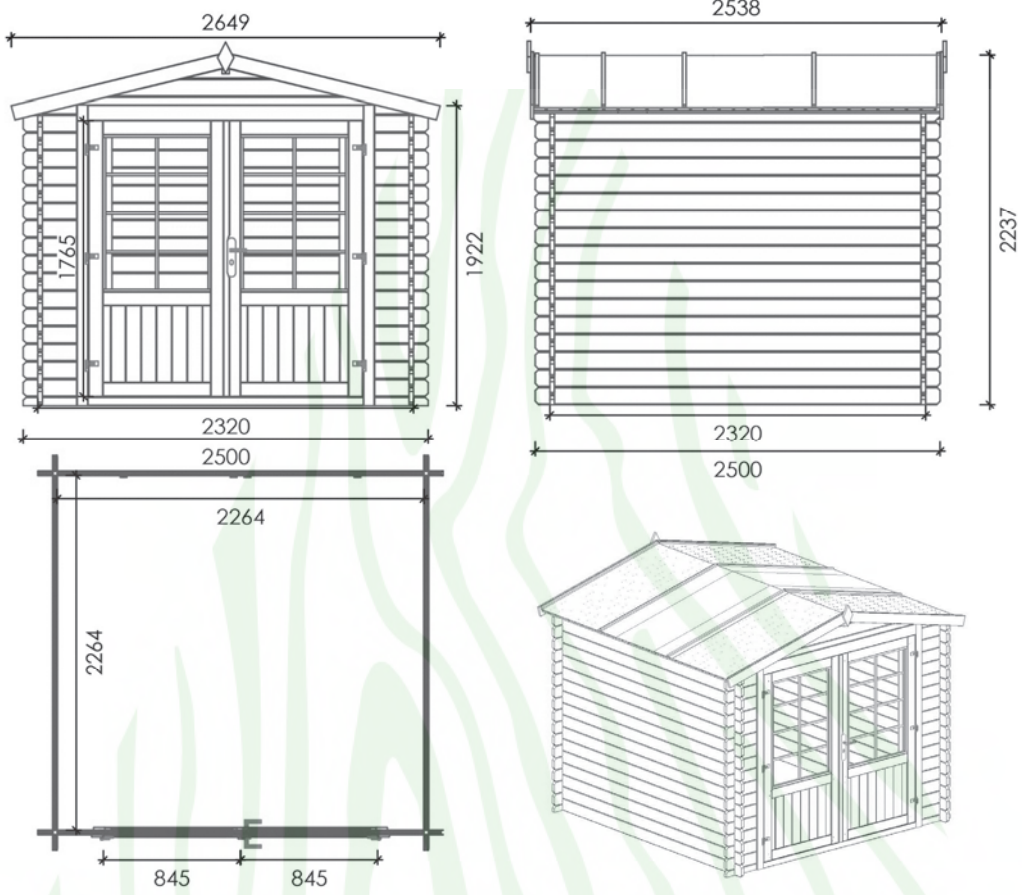



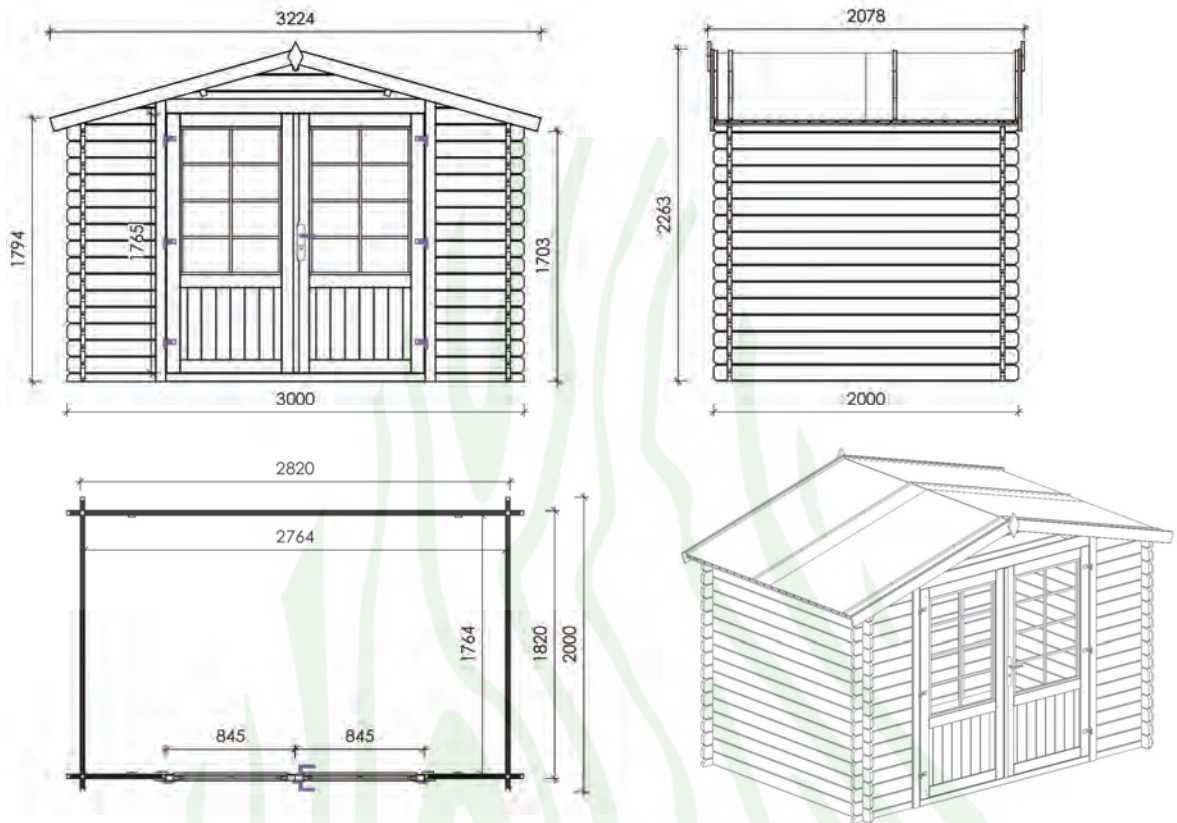



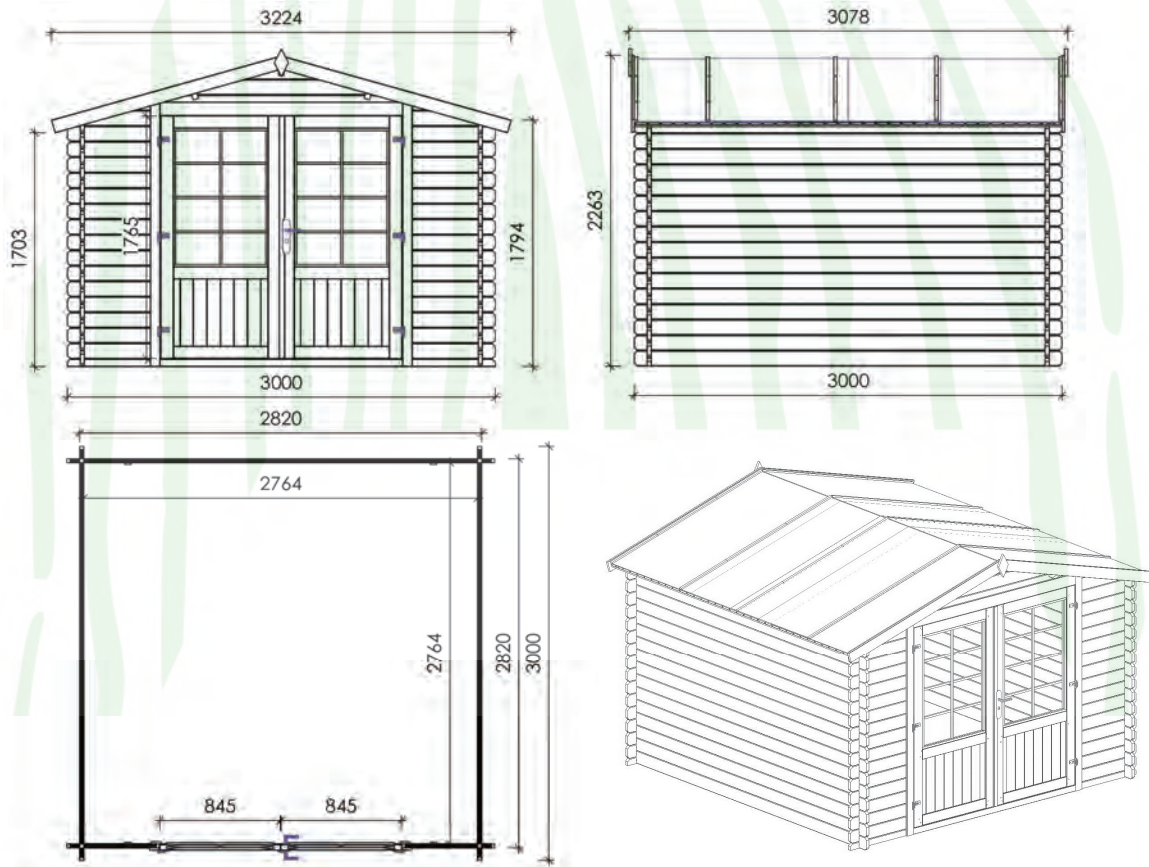











DOM140-4 300x200 28mm













DOM349-2 300x300 28mm







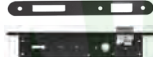
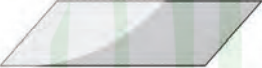

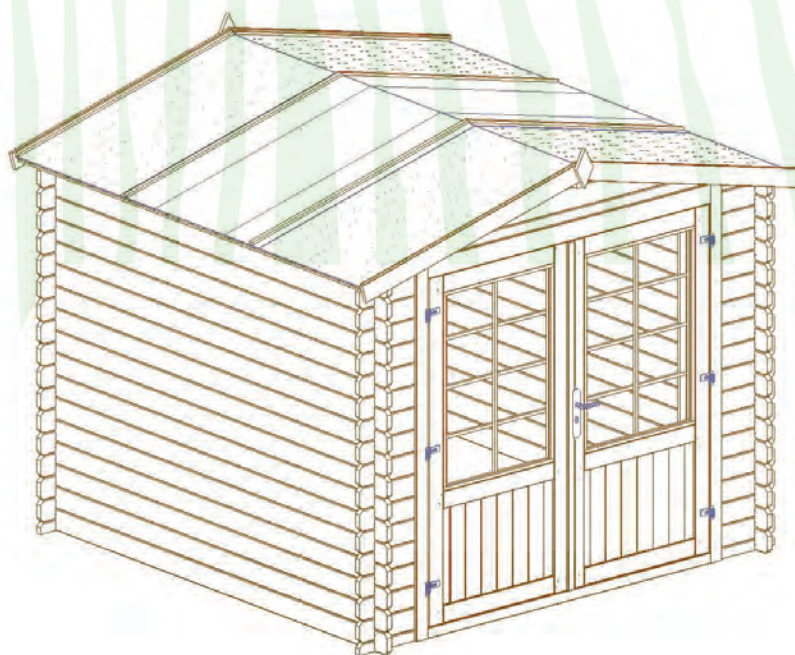













DOM521-1 250x250 28mm









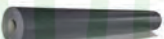



nr	Element	Size (mm)			pcs	miss	dama- ged
		d	h	L			
1		28	121	2500	48		
2							
3		28	65	2500	1		
4		28	65	2500	1		
5		28	121	370	32		
6		28	113	2500	2		
7		13	45	2000	4		
8	SZC99-1 	28	340	2500	2		
9		38	90	2500	1		
10	OSCP01 	61	82	1926	1		
11	OSCL01 	61	82	1926	1		
12	NAD01 	61	112	1746	1		
13	PRO01 	16	55	1700	1		
14	DRZ03-04 	38	845	1765	1		
15		16	16	1000	26		
16		16	99	1330	58		
17		13	22	1150	16		
18		16	95	1365	4		
19		19	110	165	2		
20		3	1000	3000	3		

nr	Element	Size	pcs	miss	dam.
A		3,5x25	9		
B		3,5x30	68		
C		3,5x35	54		
D		3,5x40	24		
F		1,4x30	102		
G		2,0x40	250		
H		6,0x60	4		
J			6		
K			2		
L			1		
M			1		
N		660x1000	2		









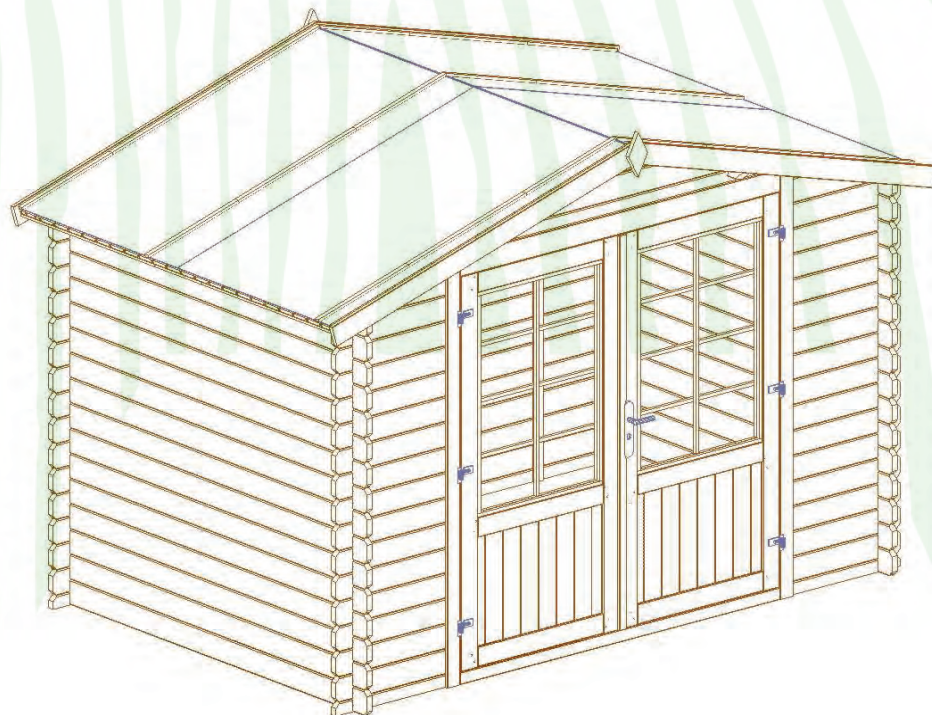





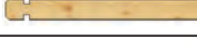

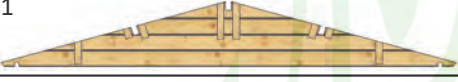

DOM140-4 300x200 28mm













nr	Element	Size (mm)			pcs	miss	dama- ged
		d	h	L			
1		28	121	2000	30		
2		28	121	3000	15		
3		28	65	3000	1		
4		28	65	3000	1		
5		28	121	622	30		
6		28	113	2000	2		
7		13	45	2000	4		
8	SZC29-1 	28	457	3000	2		
9		38	90	2000	3		
10	OSCP01 	61	82	1926	1		
11	OSCL01 	61	82	1926	1		
12	NAD01 	61	112	1746	1		
13	PRO01 	16	55	1700	1		
14	DRZ03-04 	38	845	1765	1		
15		16	16	1000	26		
16		16	99	1640	46		
17		13	22	1150	20		
18		16	95	1680	4		
19		16	110	165	2		
20		3	1000	3000	2		
21		3	500	3000	1		

nr	Element	Size	pcs	miss	dam.
A		3,5x25	9		
B		3,5x30	84		
C		3,5x35	54		
D		3,5x40	24		
F		1,4x30	102		
G		2,0x40	308		
H		6,0x60	4		
J			6		
K			2		
L			1		
M			1		
N		660x1000	2		



DOM349-2 300x300 28mm

nr	Element	Size (mm)			pcs	miss	dama- ged
		d	h	L			
1							
2		28	121	3000	45		
3		28	65	3000	1		
4		28	65	3000	1		
5		28	121	622	30		
6		28	113	3000	2		
7		13	45	2000	4		
8	SZC29-1 	28	457	3000	2		
9		38	90	3000	3		
10	OSCP01 	61	82	1926	1		
11	OSCL01 	61	82	1926	1		
12	NAD01 	61	112	1746	1		
13	PRO01 	16	55	1700	1		
14	DRZ03-04 	38	845	1765	1		
15		16	16	1000	26		
16		16	99	1640	68		
17		13	22	1150	26		
18		16	95	1680	4		
19		16	110	165	2		
20		3	1000	3500	4		

nr	Element	Size	pcs	miss	dam.
A		3,5x25	9		
B		3,5x30	108		
C		3,5x35	54		
D		3,5x40	24		
F		1,4x30	102		
G		2,0x40	440		
H		6,0x60	4		
J			6		
K			2		
L			1		
M			1		
N		660x1000	2		

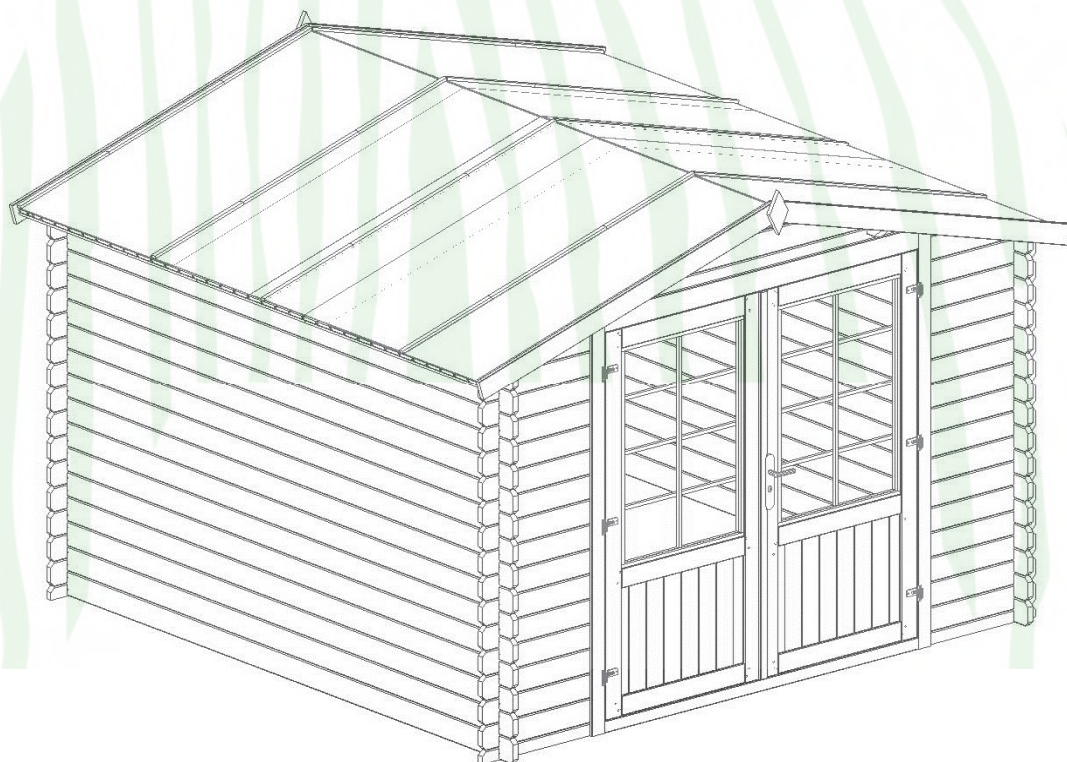

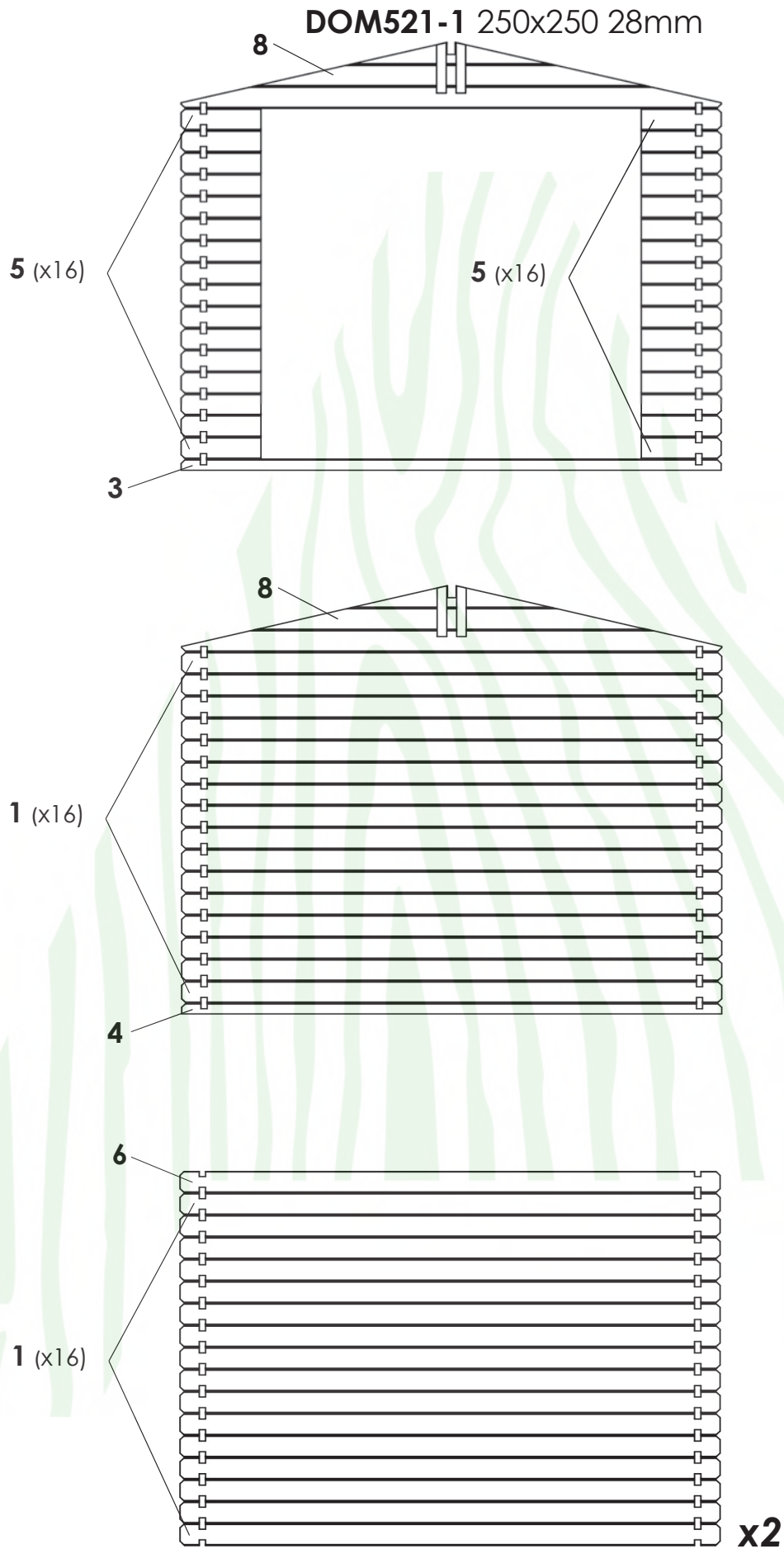

DOM140-4 300x200 28mm
DOM349-2 300x300 28mm

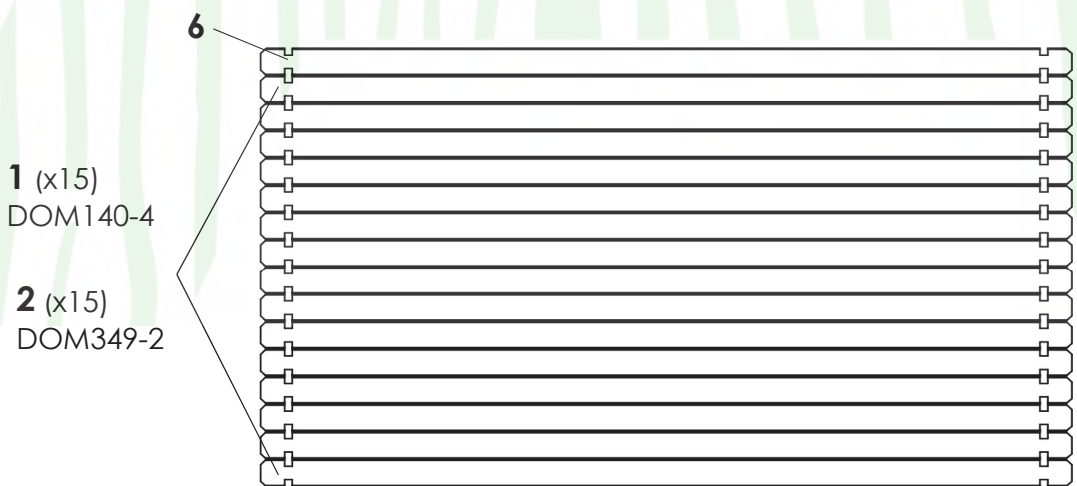
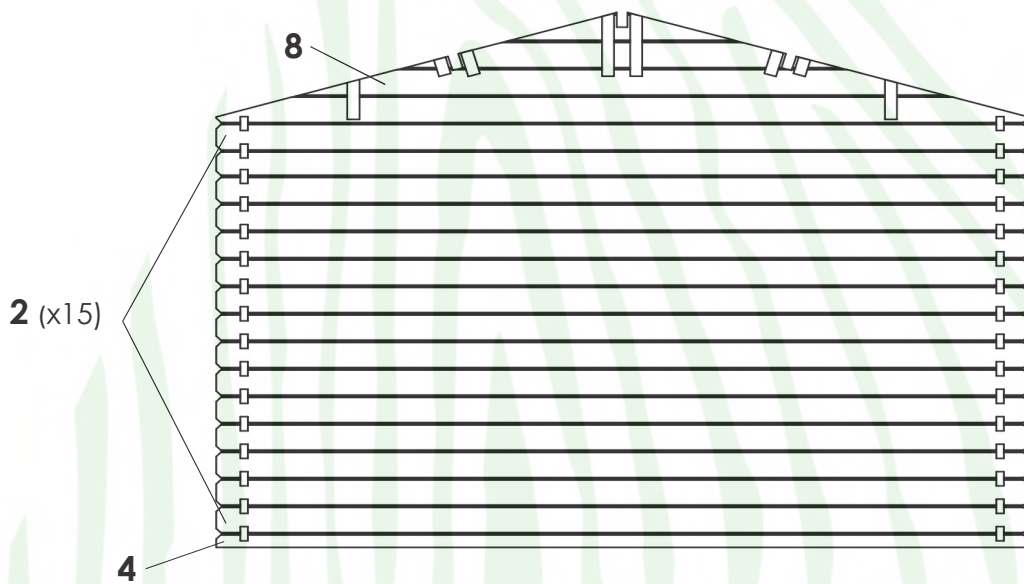
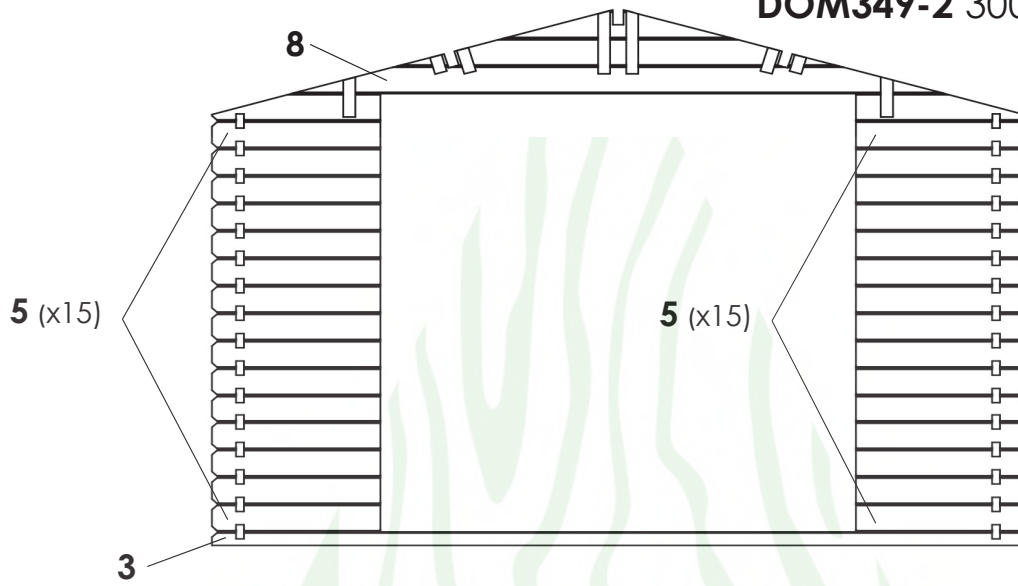

x2

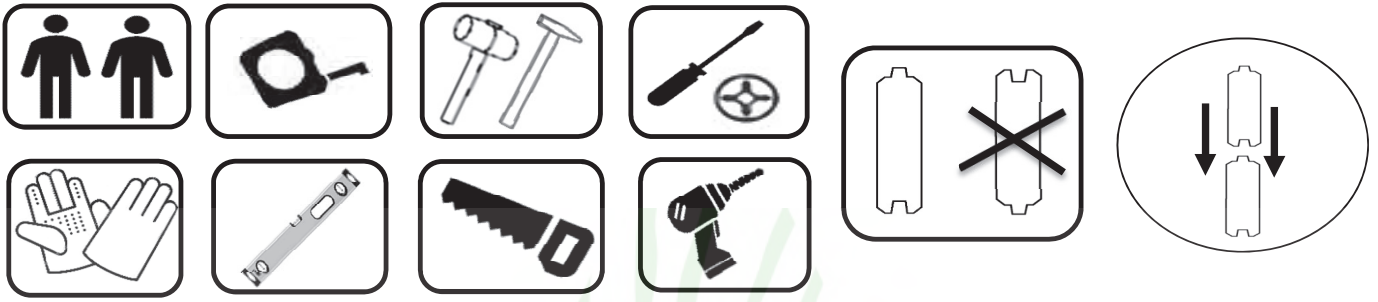

min. 100mm

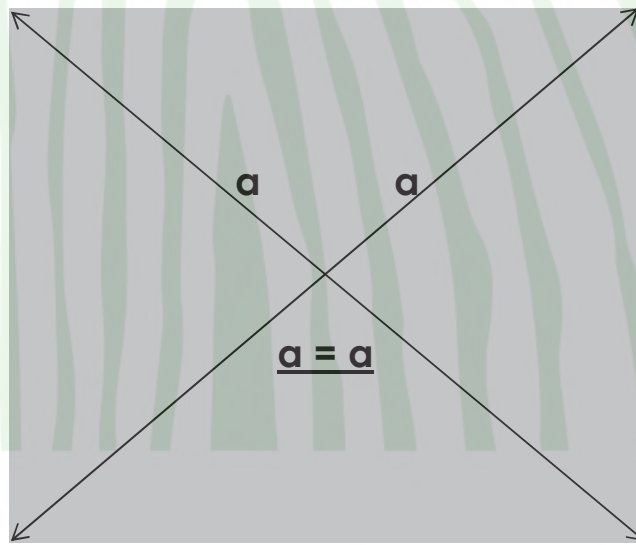

2320 mm (DOM521-1)
 1820 mm (DOM140-4)
 2820 mm (DOM349-2)

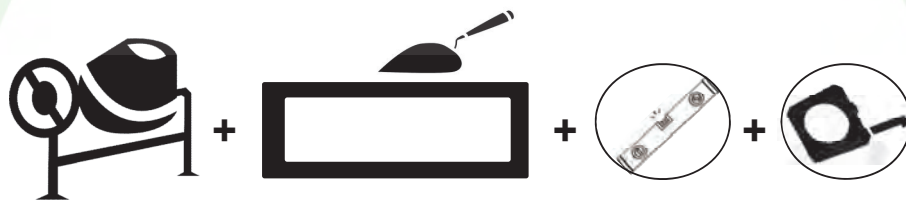

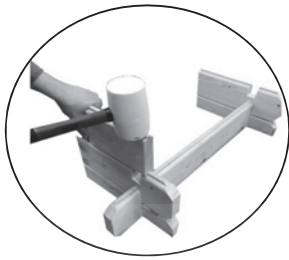

1

1 (DOM521-1)
2 (DOM140-4, DOM349-2)

1 (DOM521-1, DOM140-4)
2 (DOM349-2)

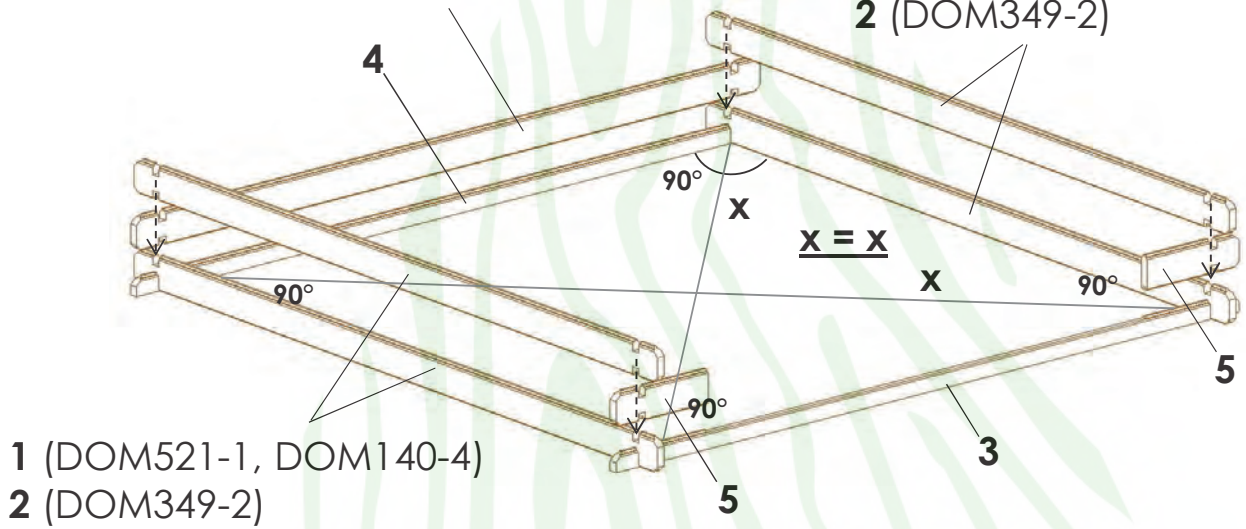

1 (DOM521-1, DOM140-4)
2 (DOM349-2)

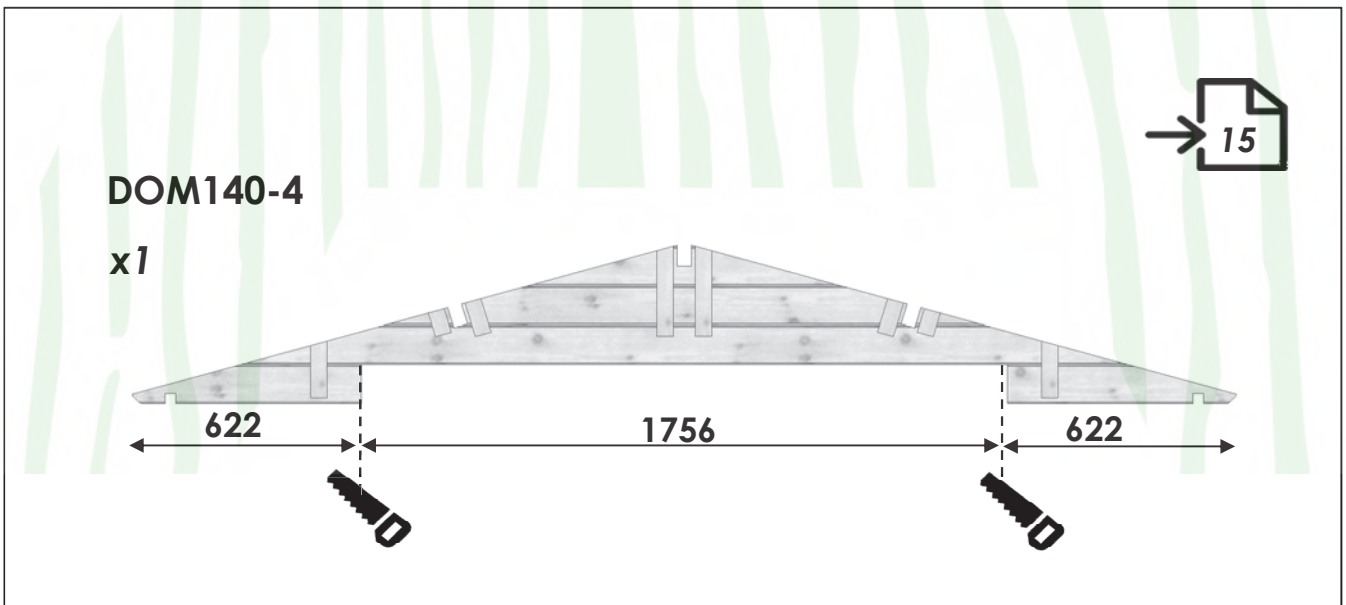

2

DOM521-1 250x250 28mm

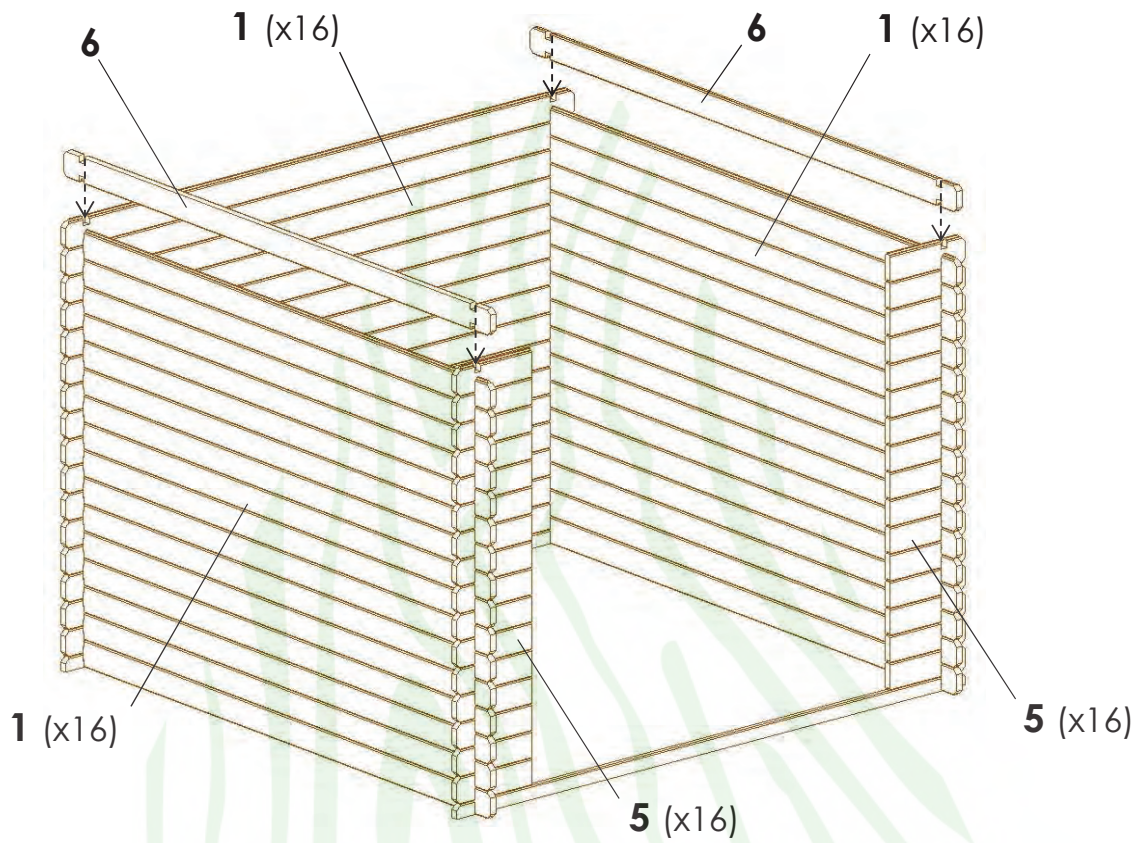

DOM140-4 300x200 28mm

DOM349-2 300x300 28mm

1 (x15) DOM140-4

2 (x15) DOM349-2

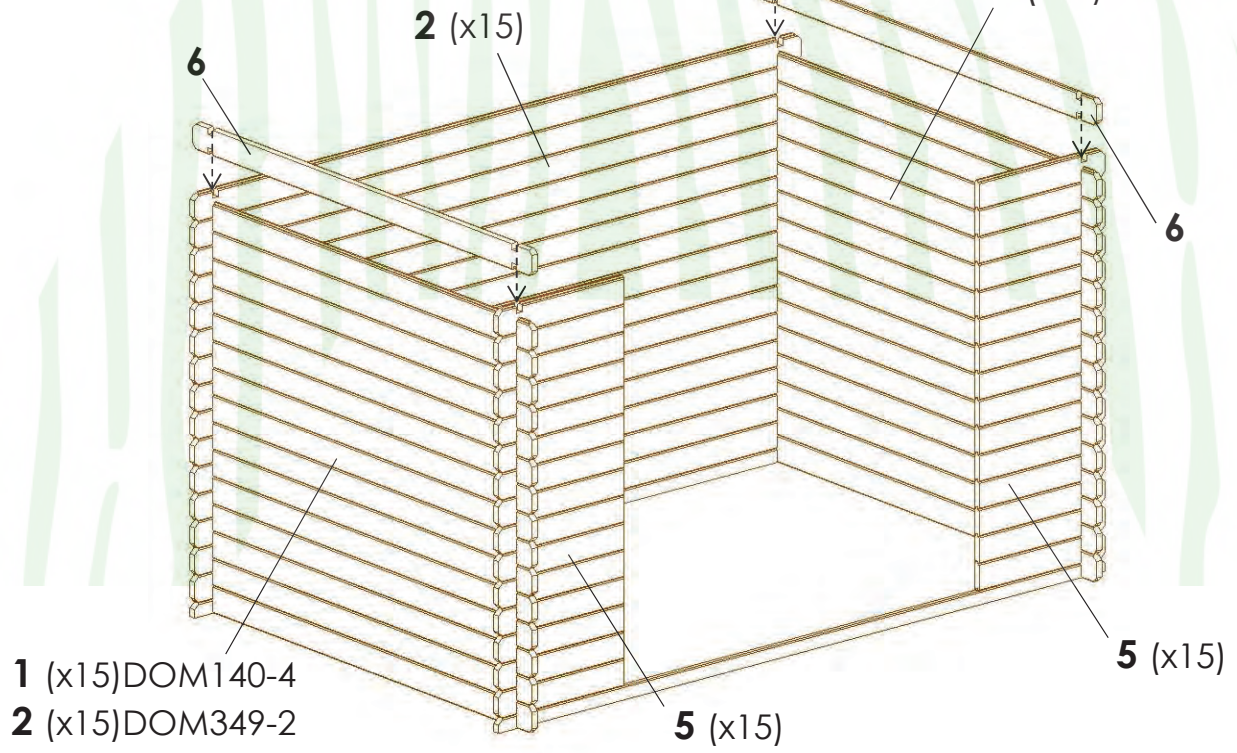

DOM521-1 250x250 28mm

3

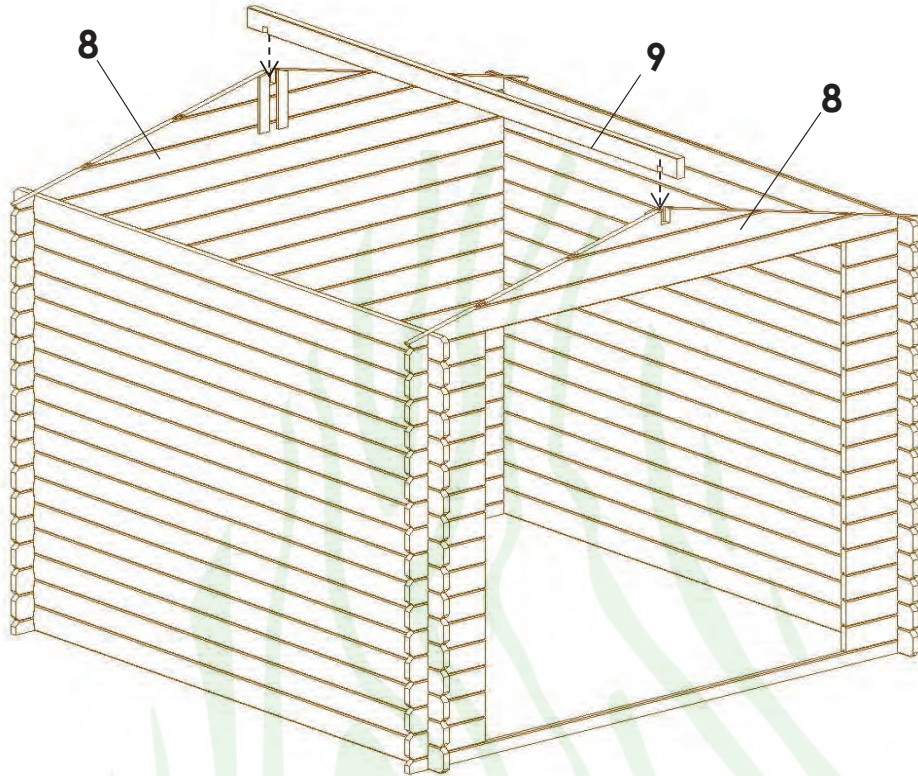

DOM140-4 300x200 28mm

DOM349-2 300x300 28mm

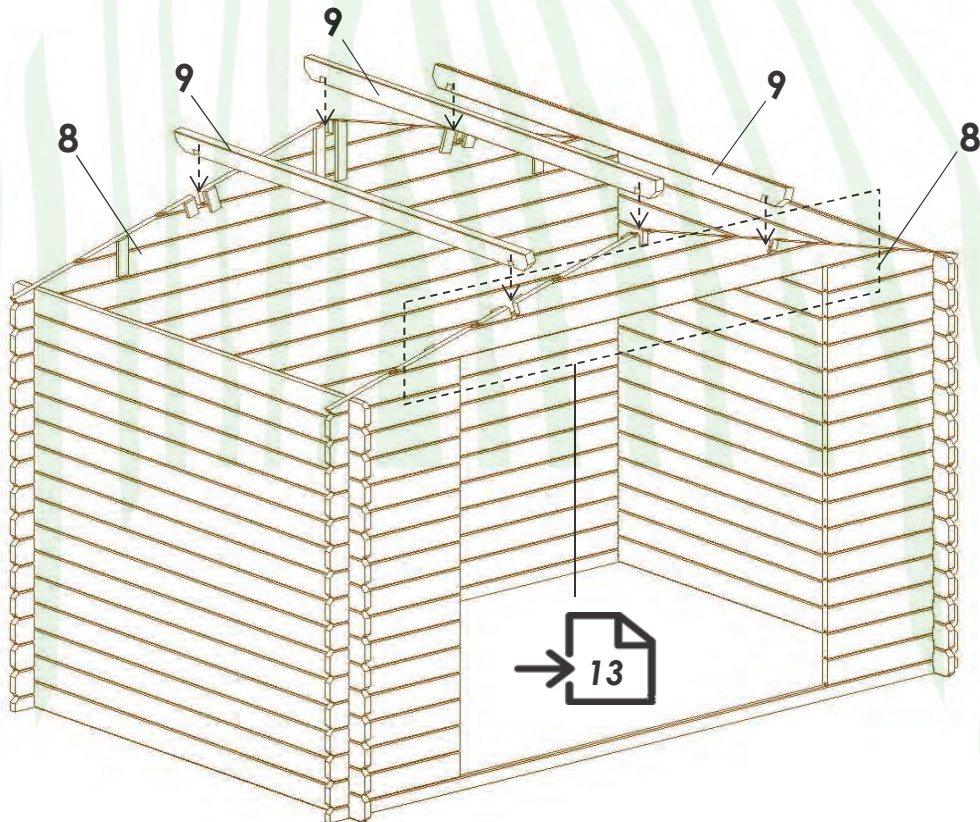

4

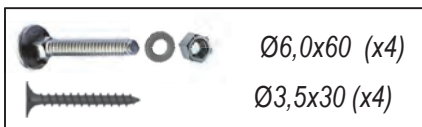
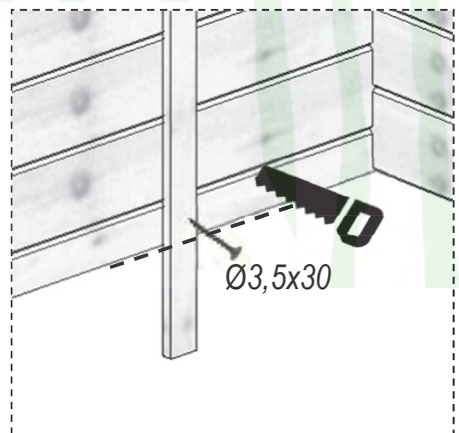
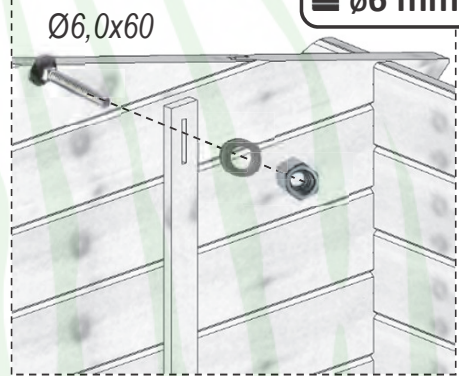
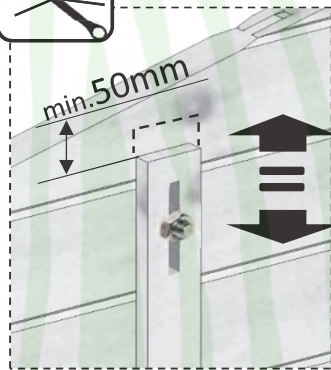
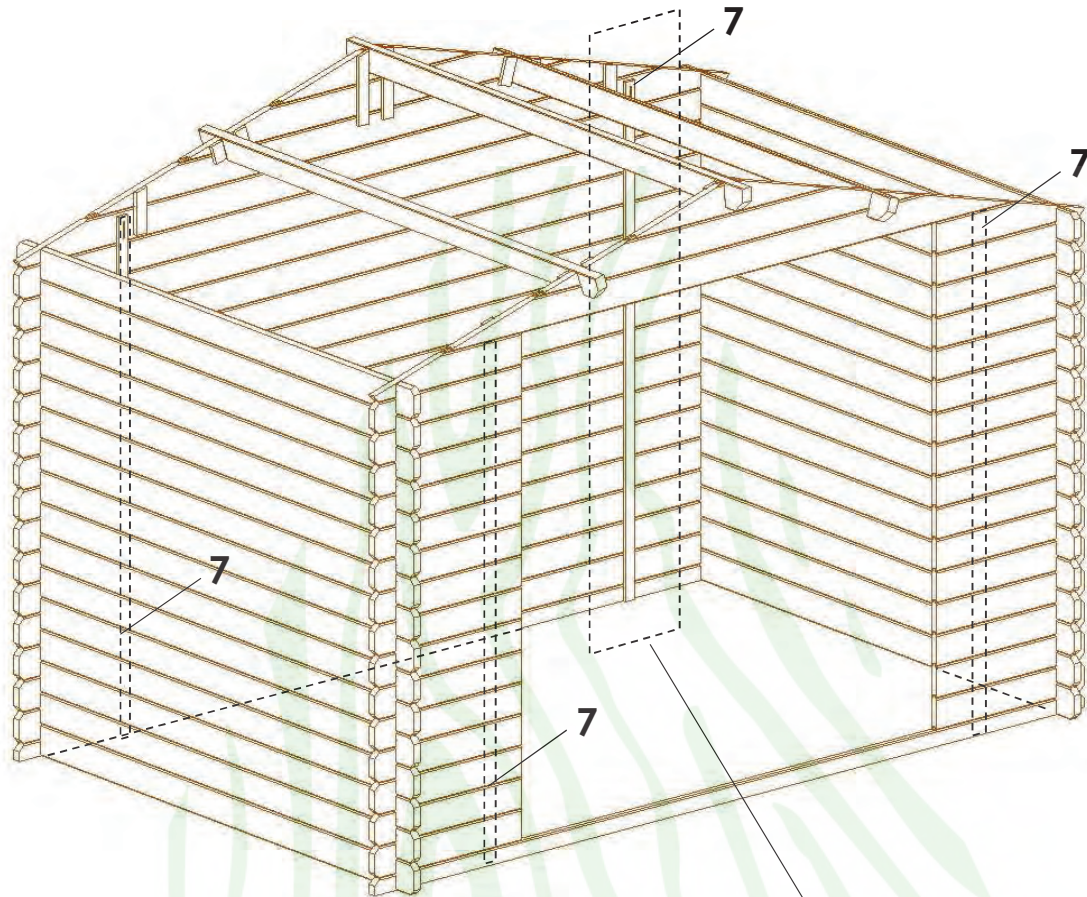

5

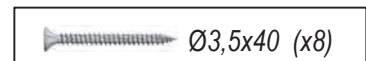
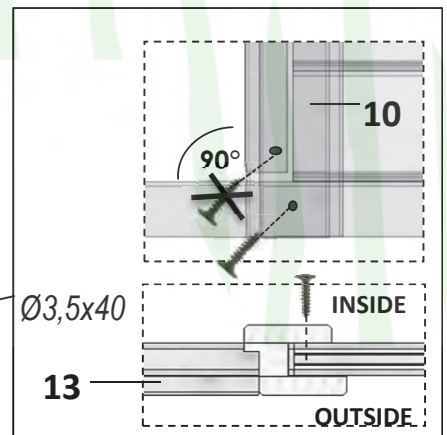
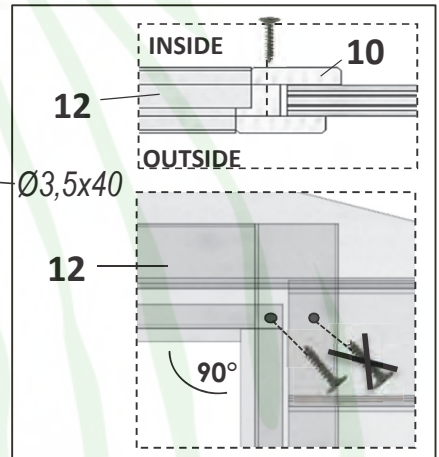
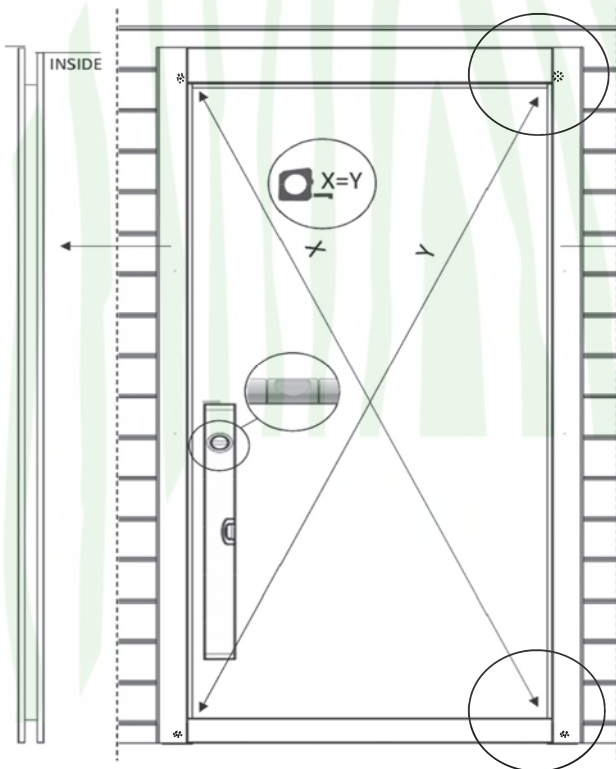
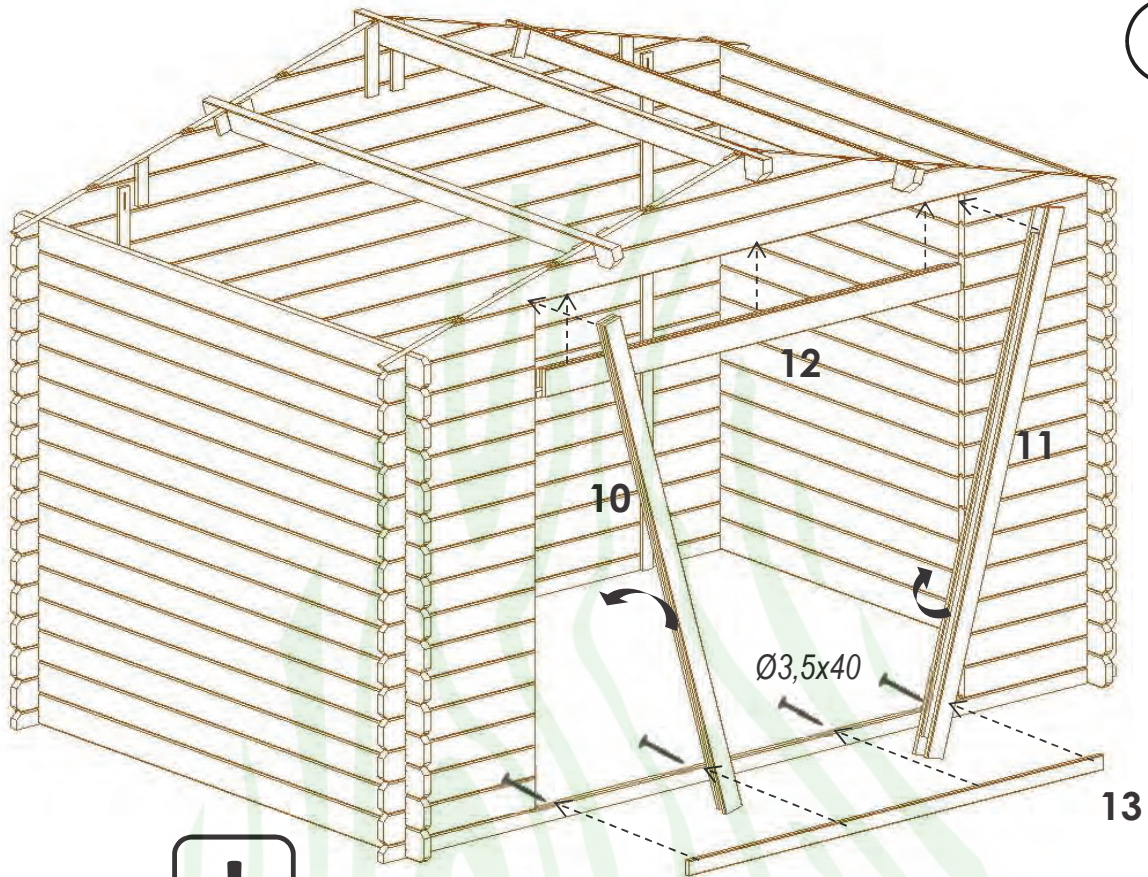

6

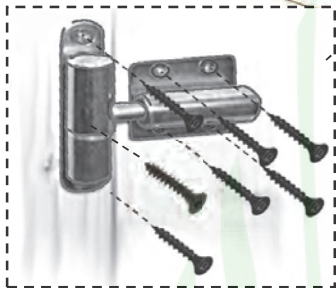
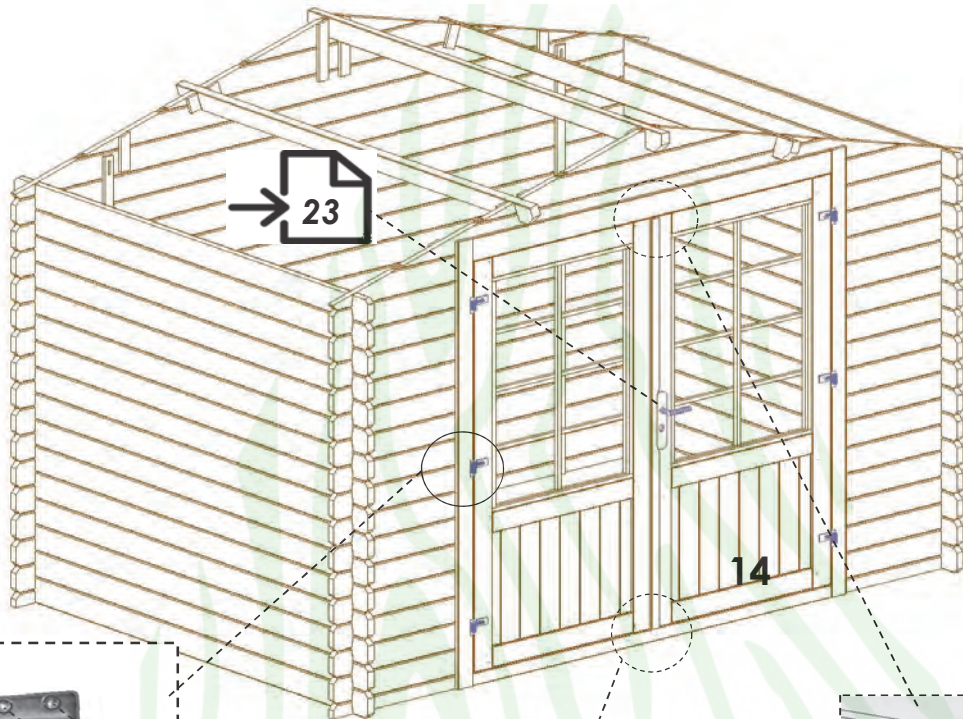

OUTSIDE $\varnothing 3,5 \times 35$ (x7)

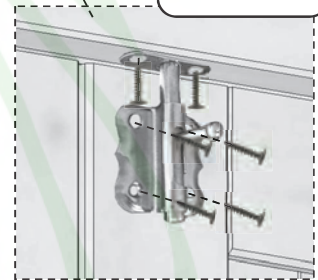
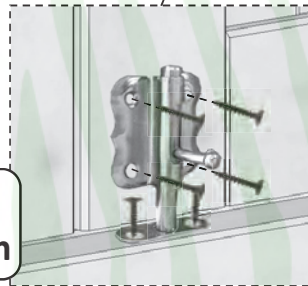

INSIDE 6x $\varnothing 3,5 \times 35$

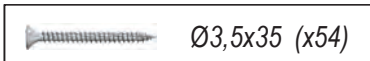

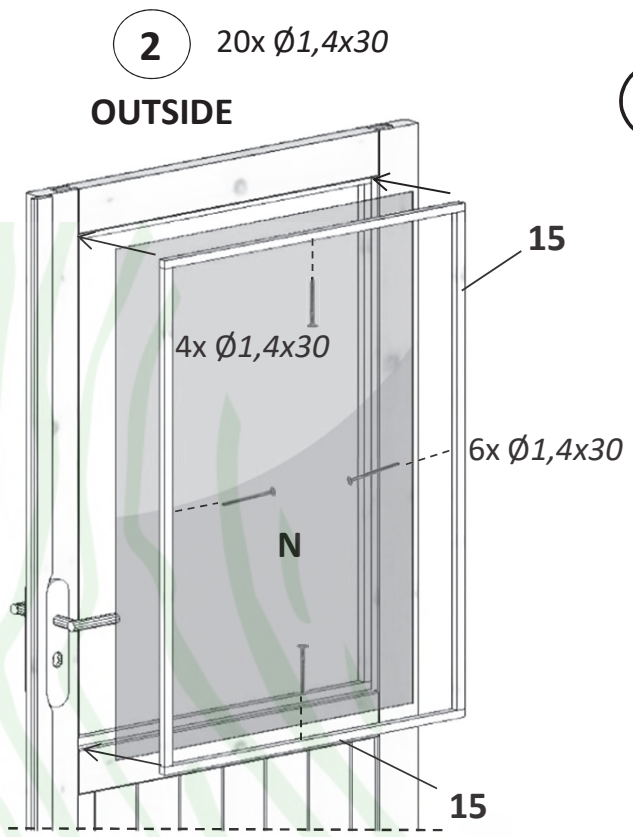
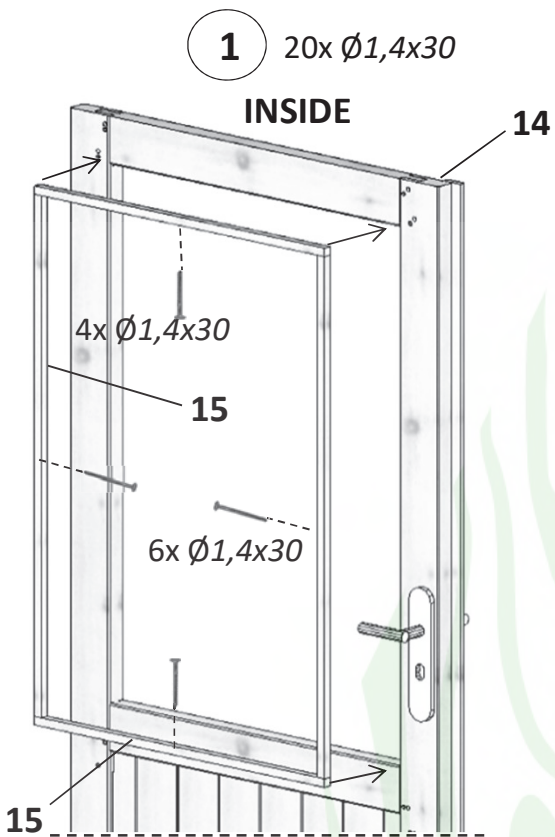

7

3 11x Ø1,4x30
INSIDE

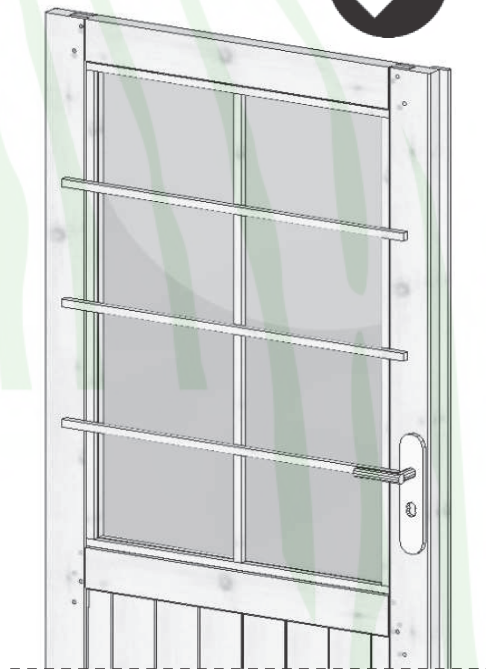
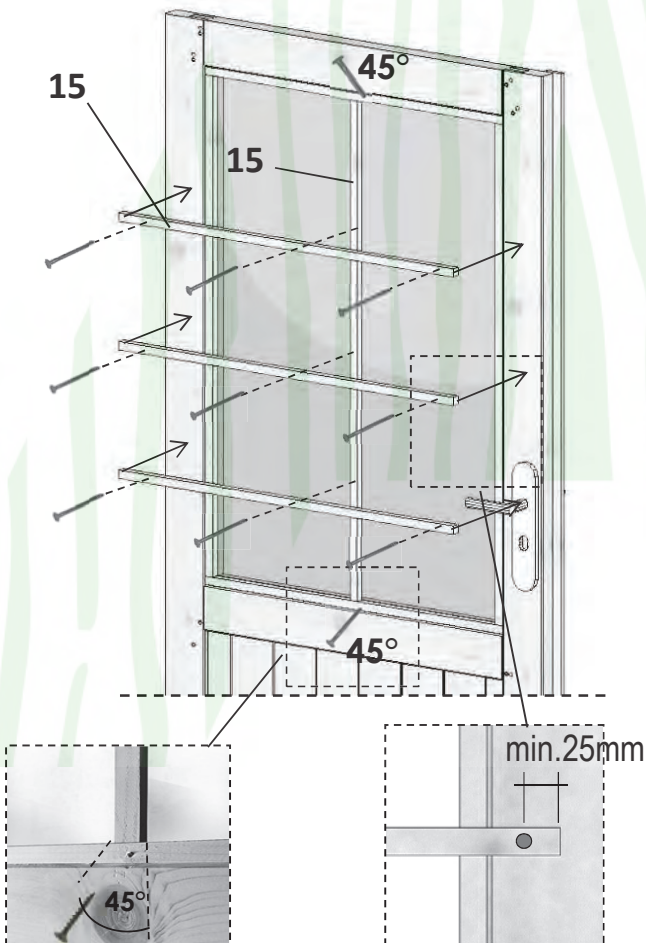

 Ø1,4x30 (x102)

8

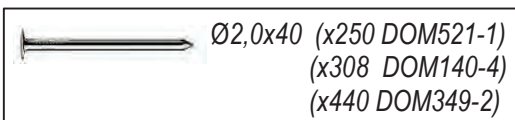
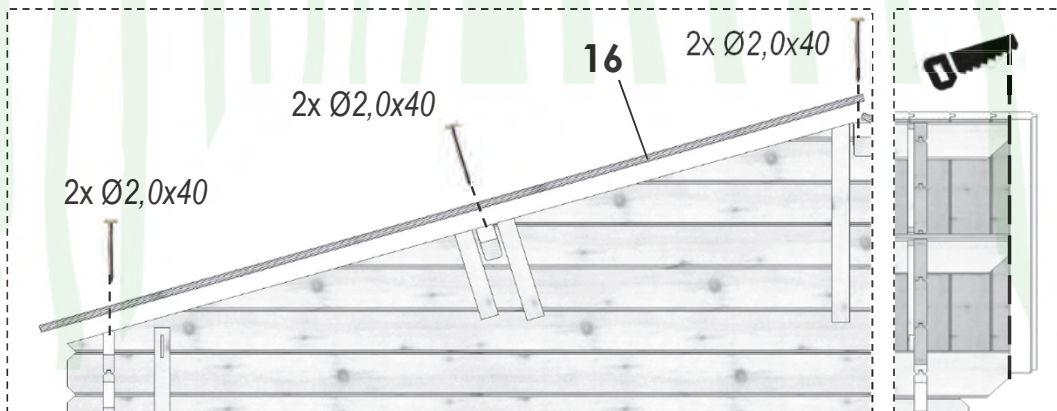
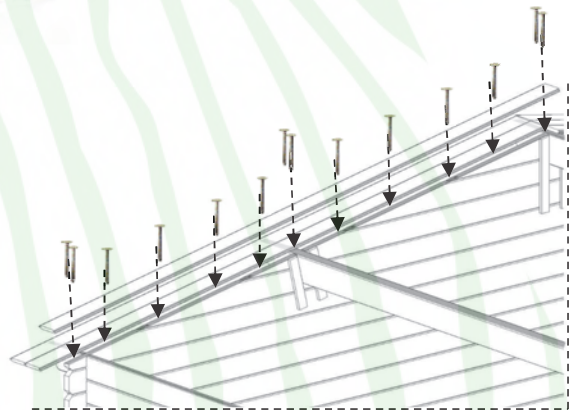
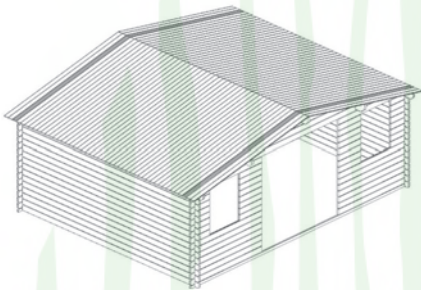
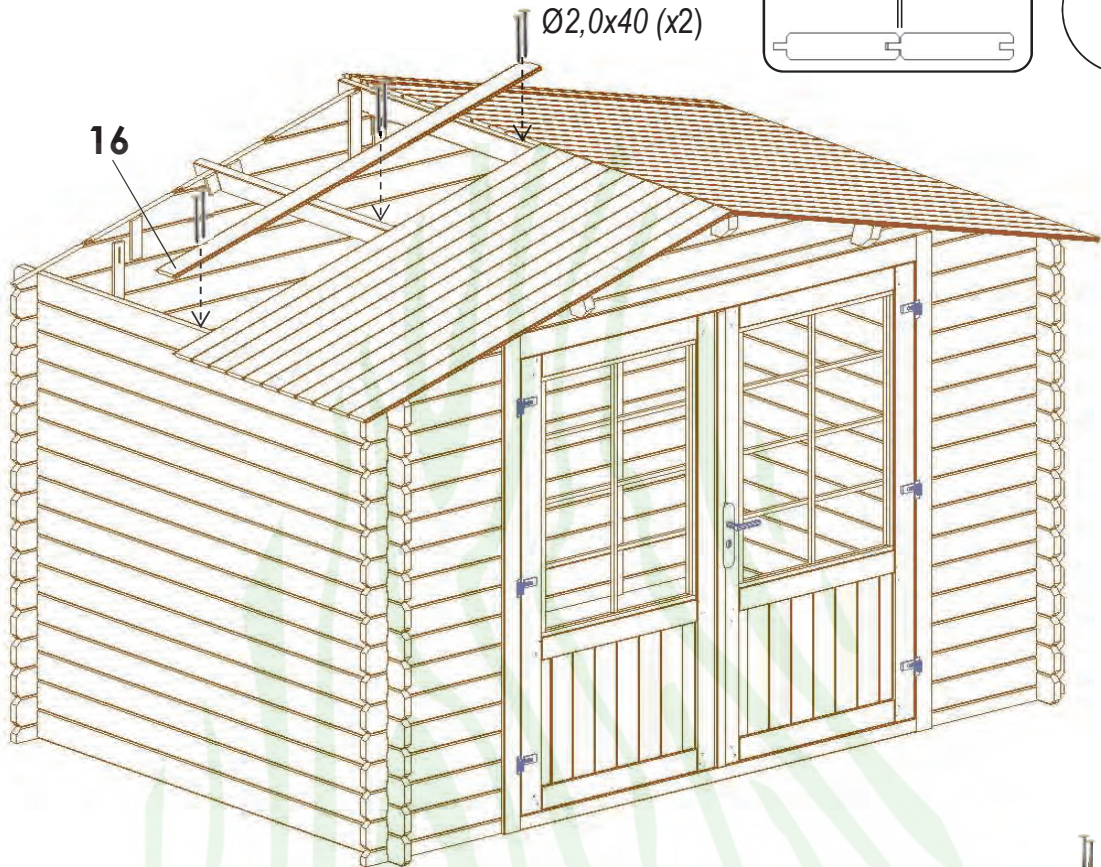
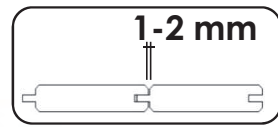

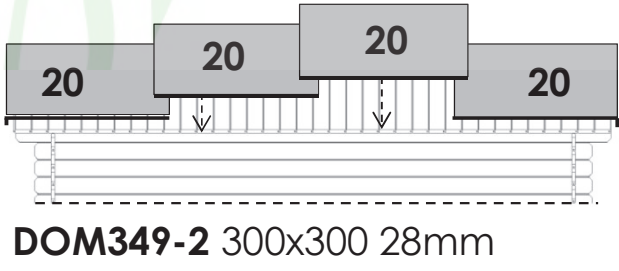
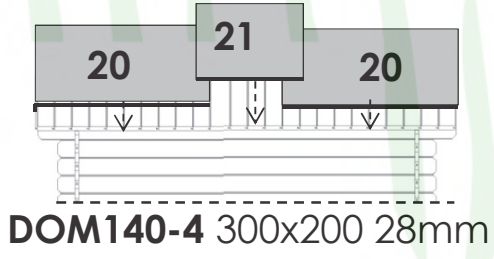
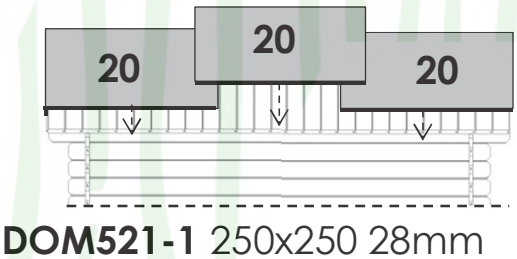
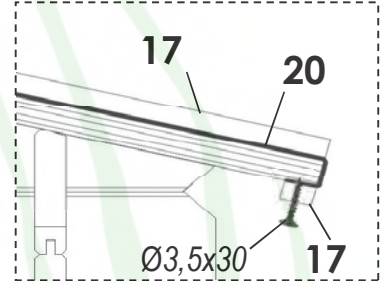
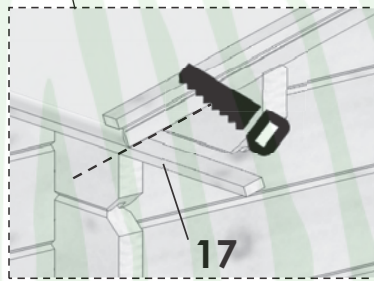
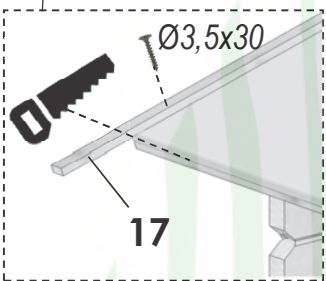
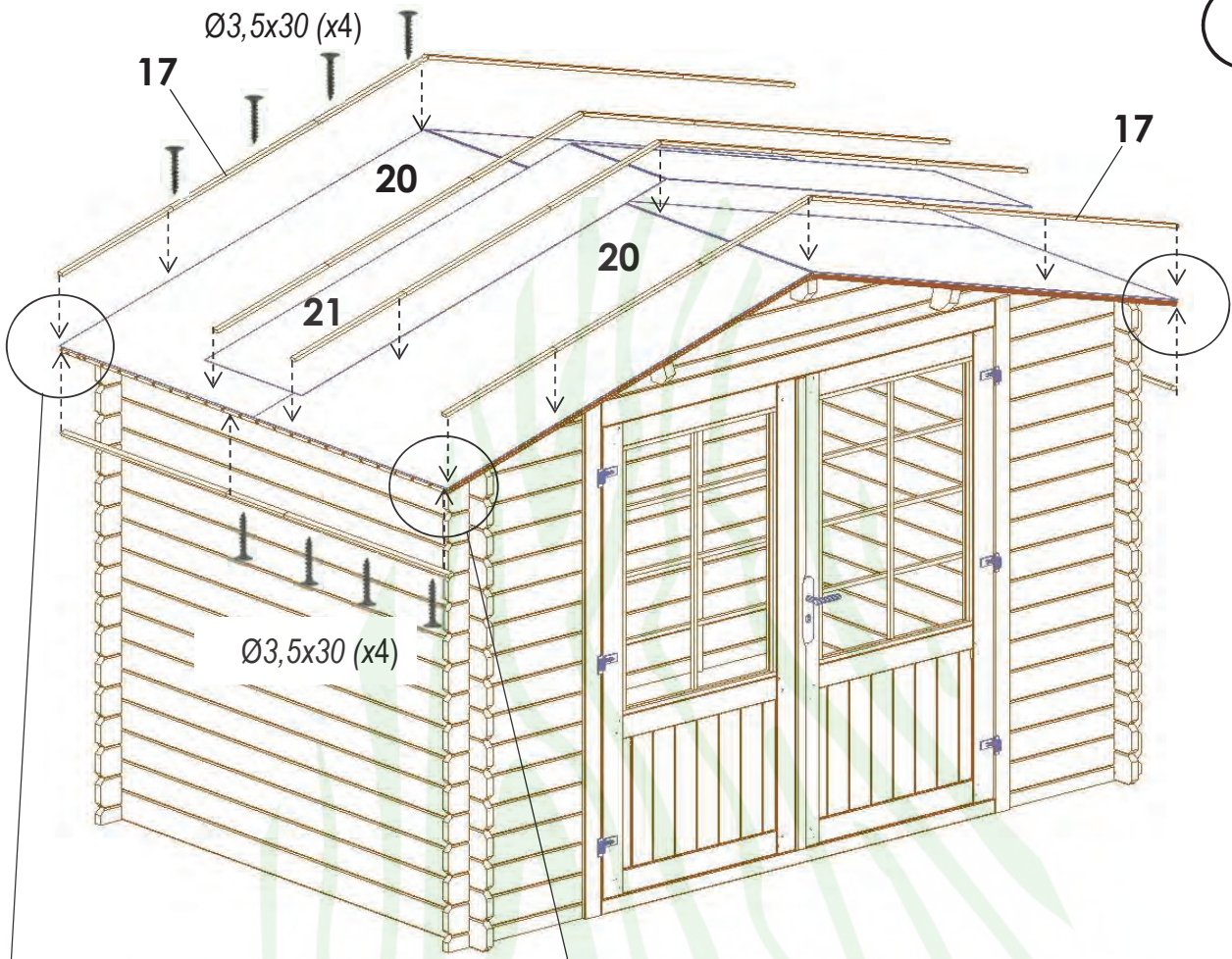

- Ø3,5x30 (x64 DOM521-1)
- (x80 DOM140-4)
- (x104 DOM349-2)

10

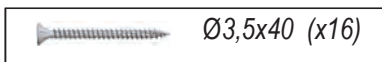
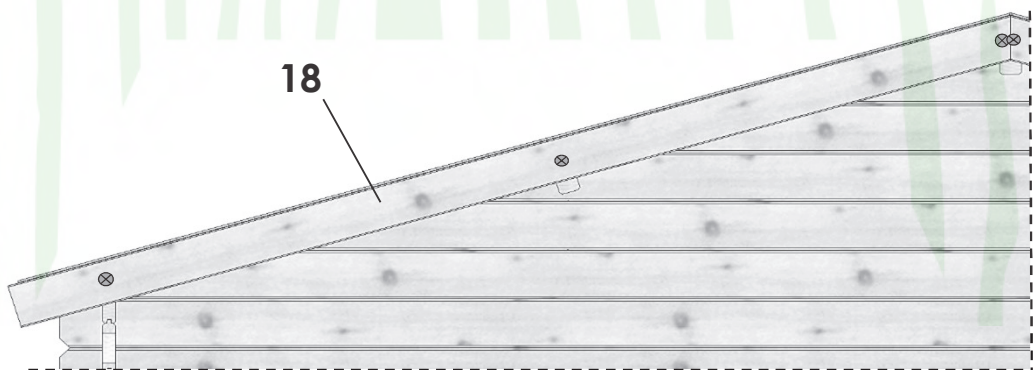
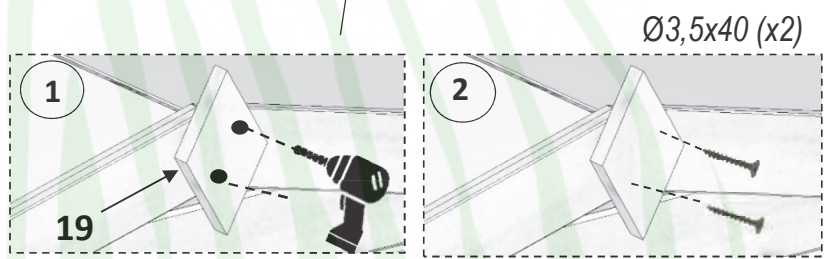
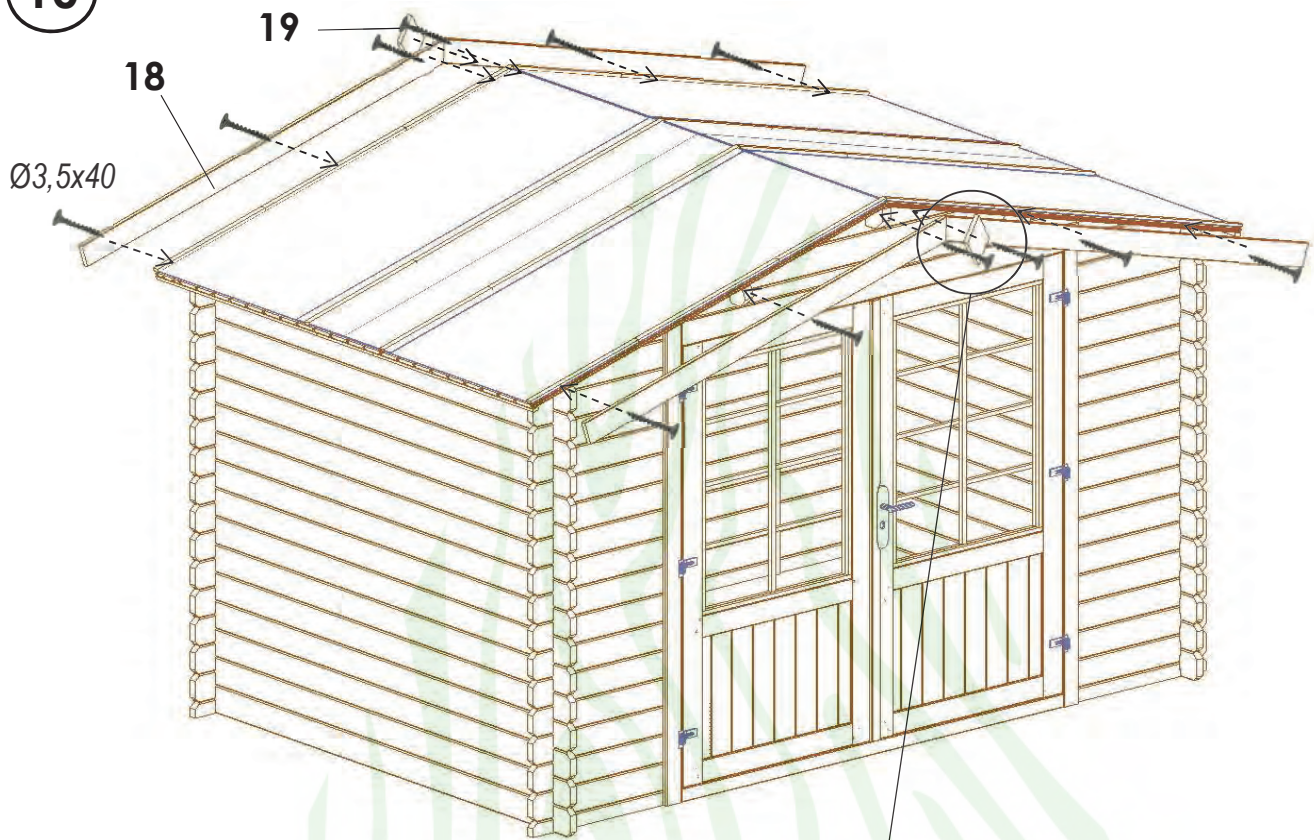

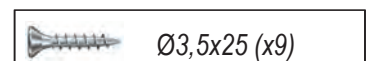
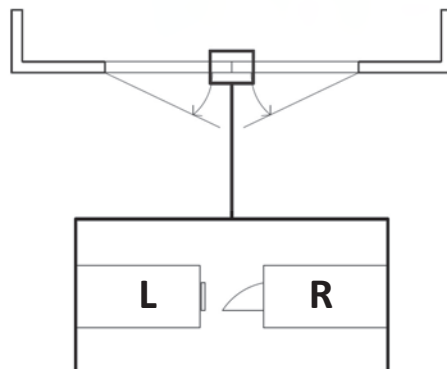
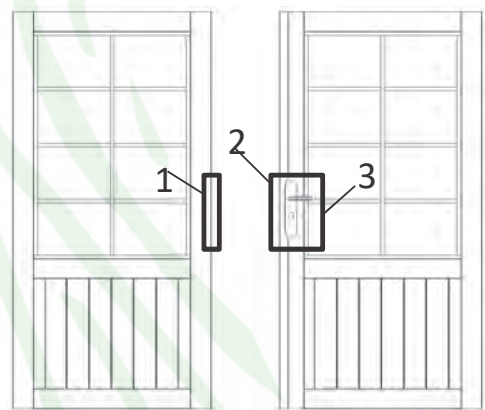
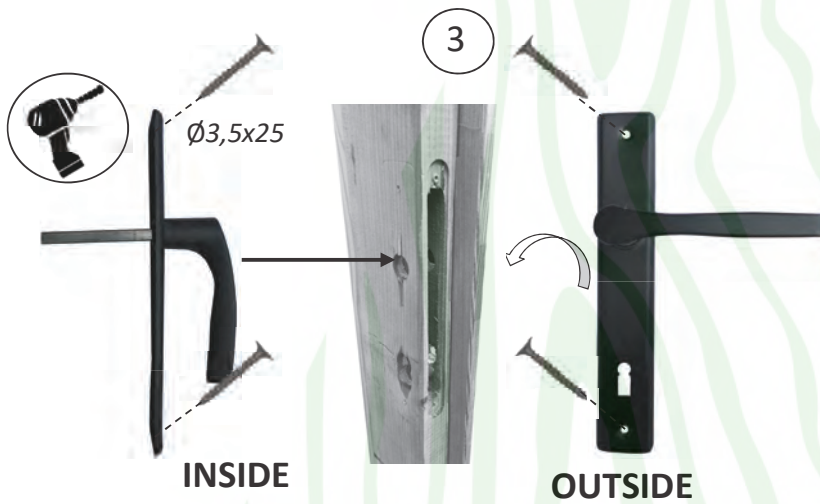
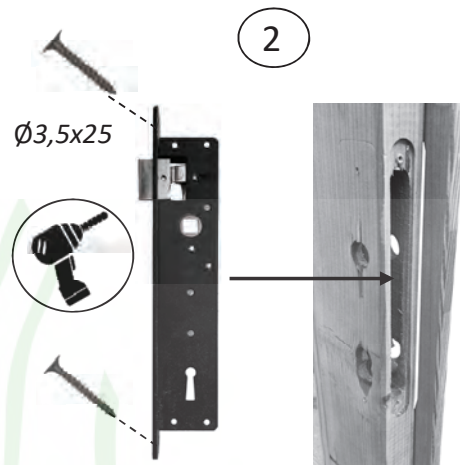
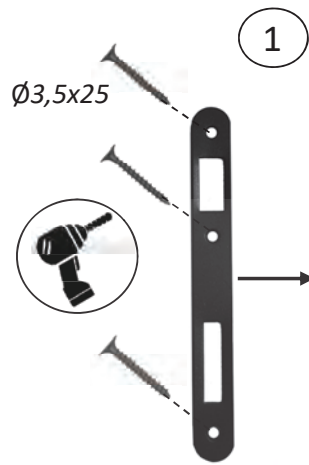

lock - change from the left to the right

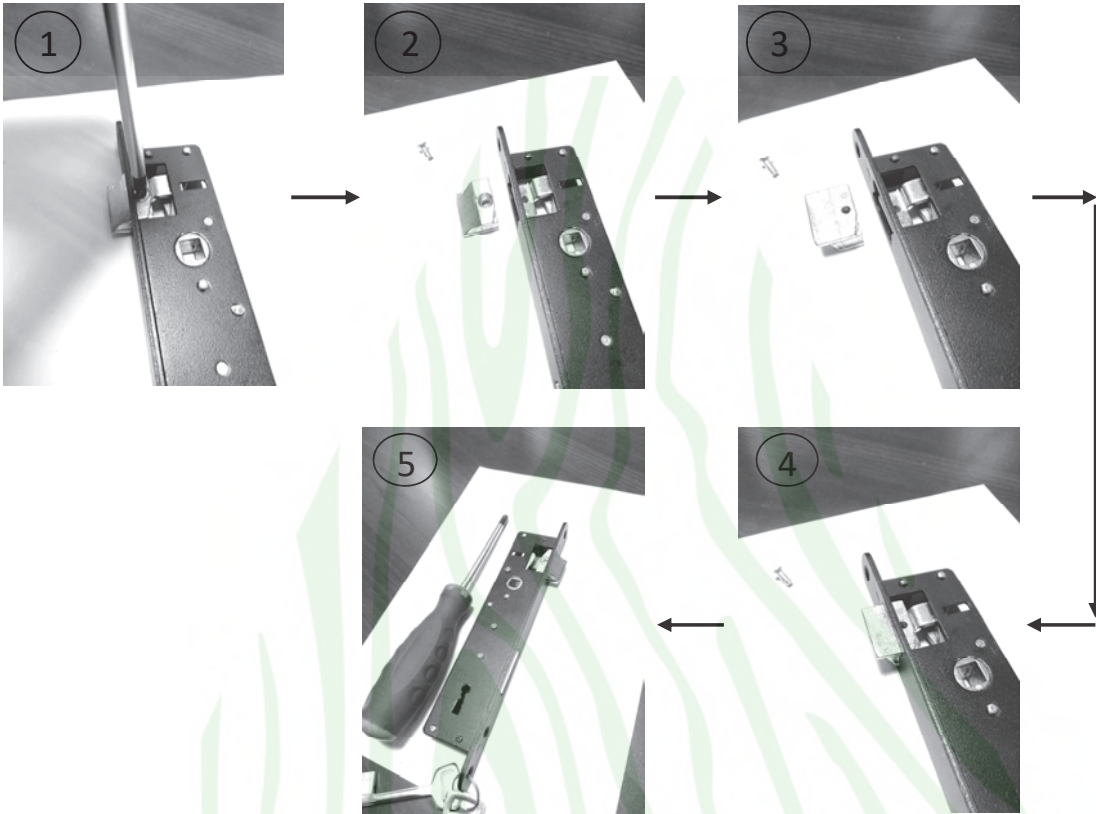

lock - change from the right to the left

