

3791

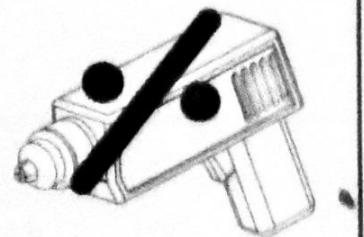
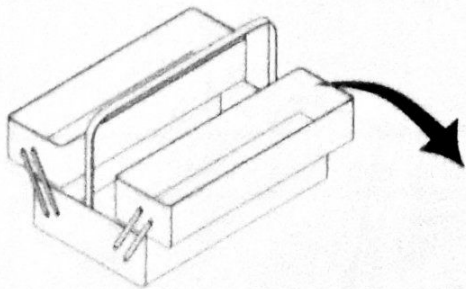
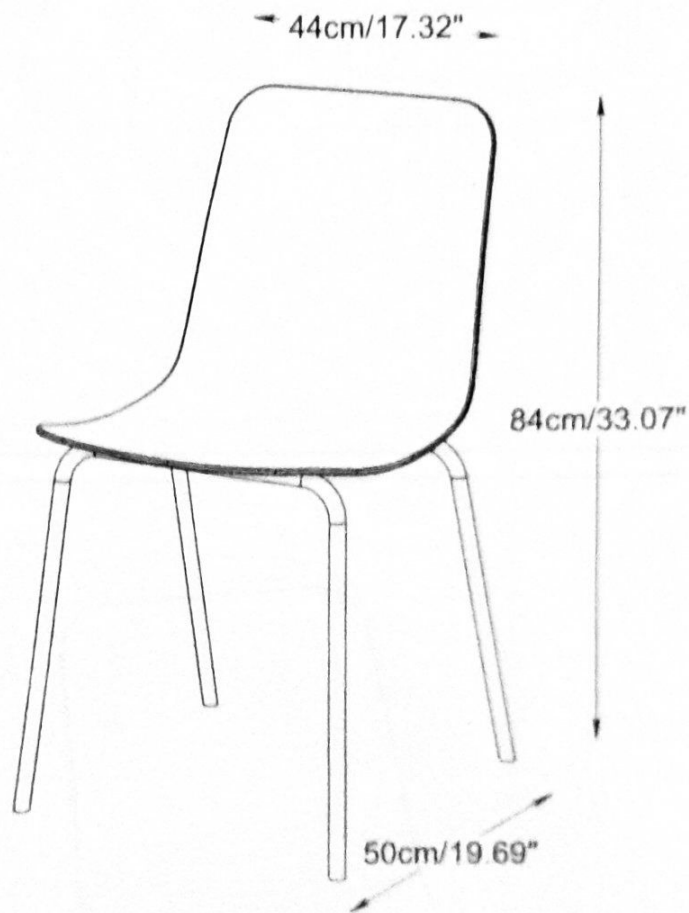

WICHTIG - FÜR SPÄTERE VERWENDUNG  
AUFBEWAHREN - SORGFÄLTIG LESEN

AVIS - Ces instructions doivent être sauvegardées  
pour utilisation future - Les instructions doivent  
être soignées

IMPORTANTE: conservar estas instrucciones  
para futuro uso - siga estas instrucciones atentamente

VÄRDTIGT - Samlevejledningen skal opbevares  
i akt for senere brug - Skal gennemlæses nøje

NOTICE - These instructions must be saved  
for future use - instructions must be followed

TEILCHECKLISTE  
LISTE DE CONTROLE  
LISTADO DE CONTROL  
TJEKLISTE  
CHECK LIST

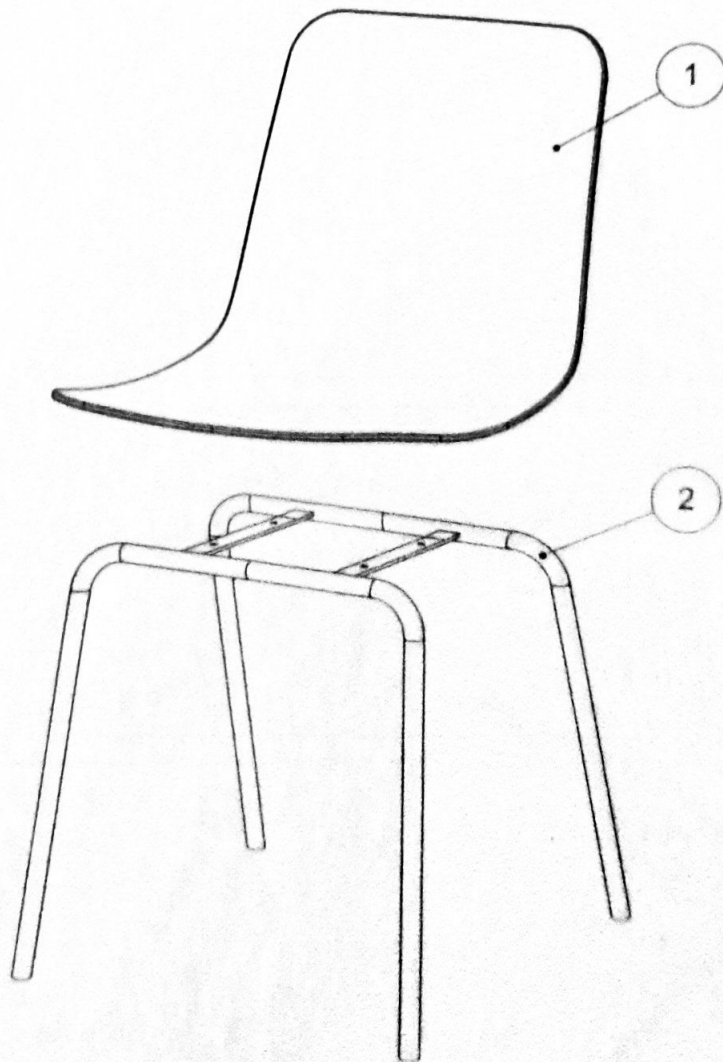

Réf/No	Réf/Art	Qty /Stck /Quanté	Size / Maß / Dimension (mm)	Qty /Stck /Quanté	✓
1		1	440x480x405		
2		1	480x480x465		



TEILCHECKLISTE - LISTE DE CONTROLE - LISTADO DE CONTROL - TJEKLISTE - CHECK LIST

an/nd	✓

Réf./No.	Réf./Art.	Qty./Stck./Quantité	✓
A	226491	4	
B	226491	4	
C	226491	1	

4 - A	4 - B	1 - C			
 <p>M6x20mm (M6x13/16")</p>	 <p>16mm (5/8")</p>	 <p>5mm (3/16")</p>			

Gezinter Kunde.  
Hier haben Sie die Möglichkeit die mitgelieferten  
Schrauben nachzumessen.

Cher Client.  
La règle ci jointe vous permet de mesurer la visserie.

Estimado cliente.  
aquí podrá medir la tornillería adjunta.

Kære kunde.  
Her har De mulighed for at måle medsendte beslag.

Dear Customer.  
Below you have the opportunity to measure the  
Enclosed Hardware.

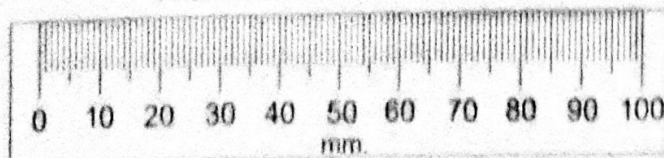

1    A x 4    B x 4    C x 1

