

ASSEMBLY INSTRUCTIONS

CHAIR MODEL#:1100564

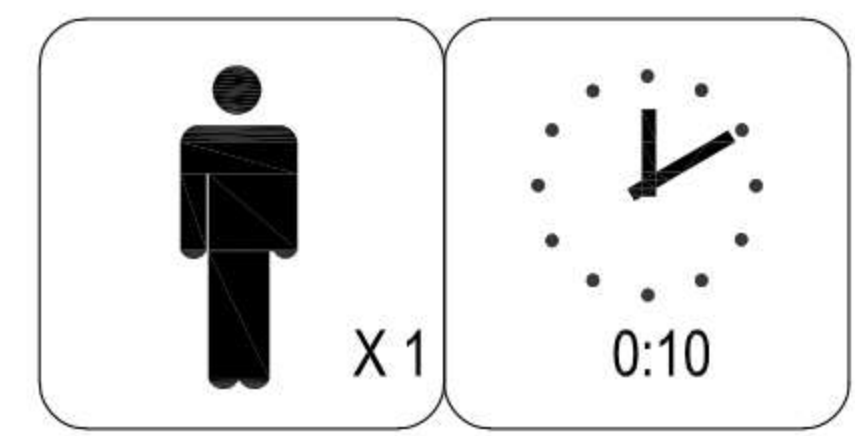
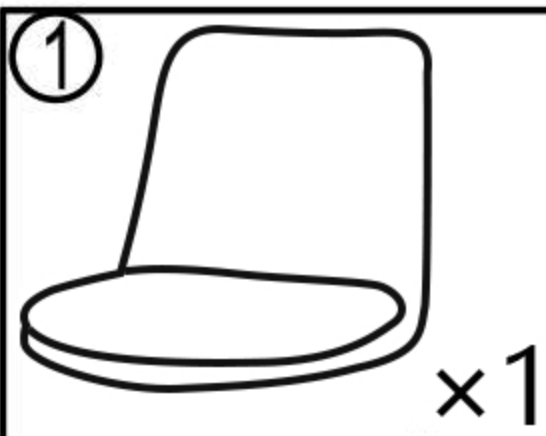
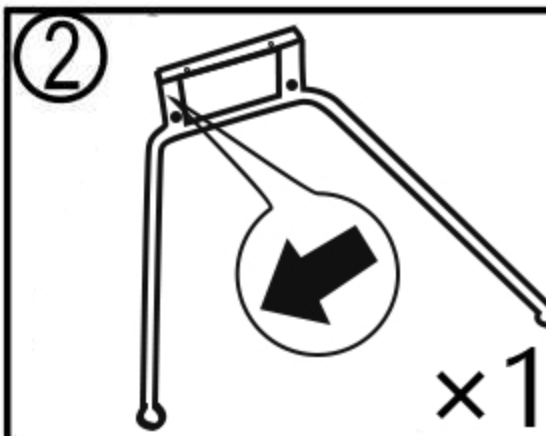
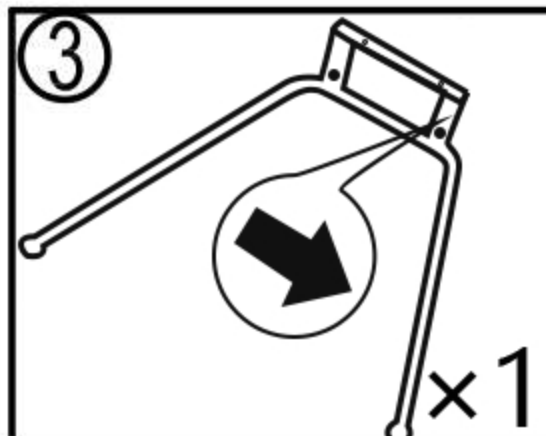
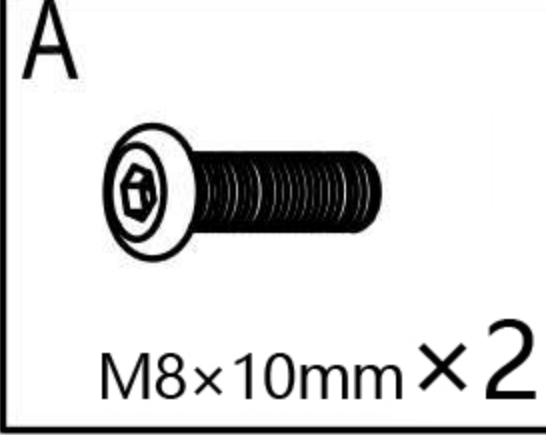
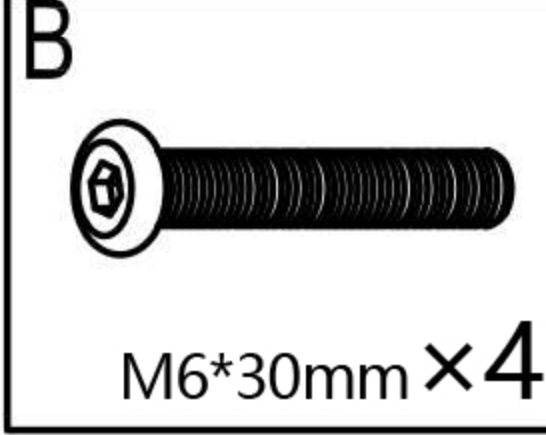
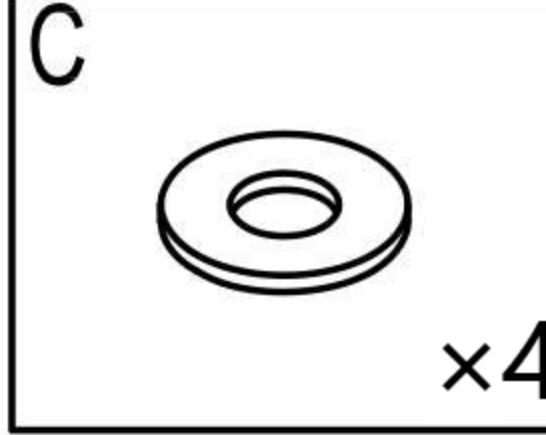
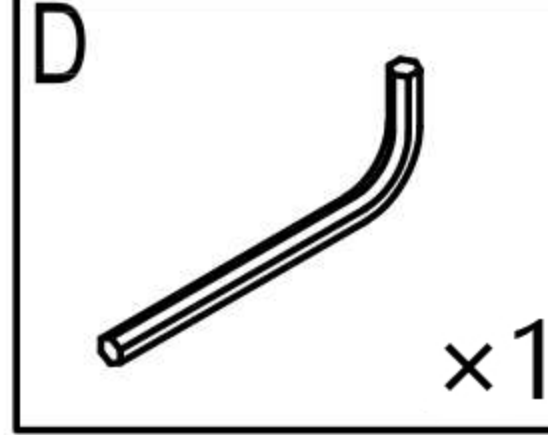

 ① x1	 ② x1	 ③ x1	
 A M8×10mm×2	 B M6*30mm×4	 C x4	 D x1

1

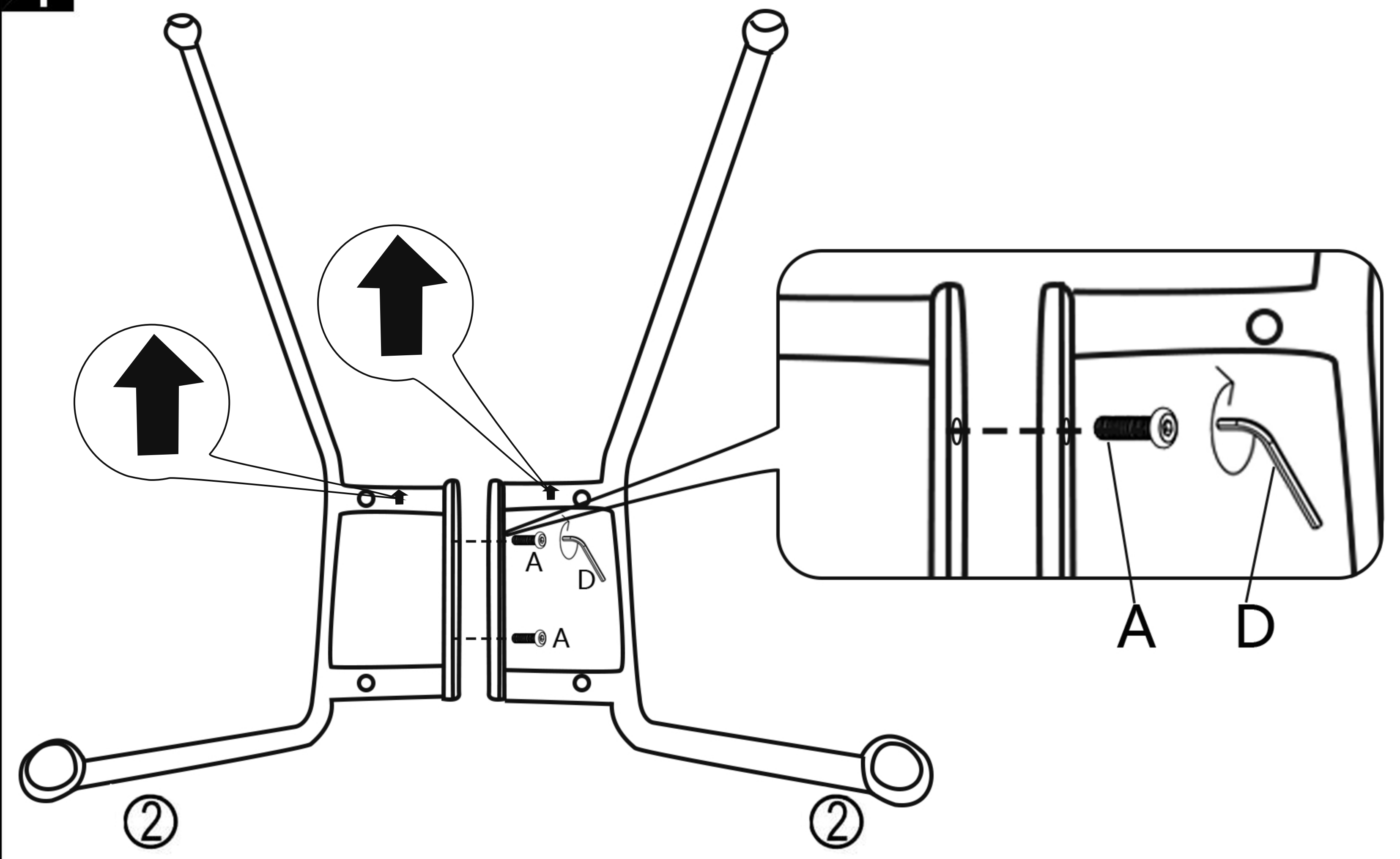

2

