

Poc

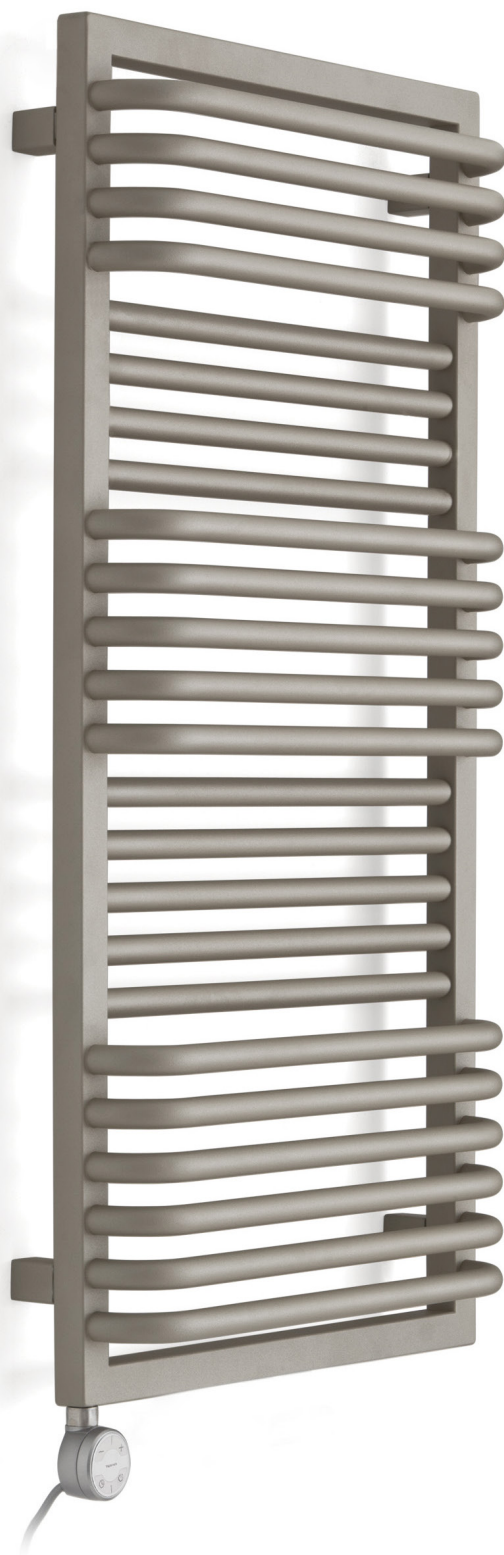

Poc

Raccordements

Chauffage central



Électrique



Mixte



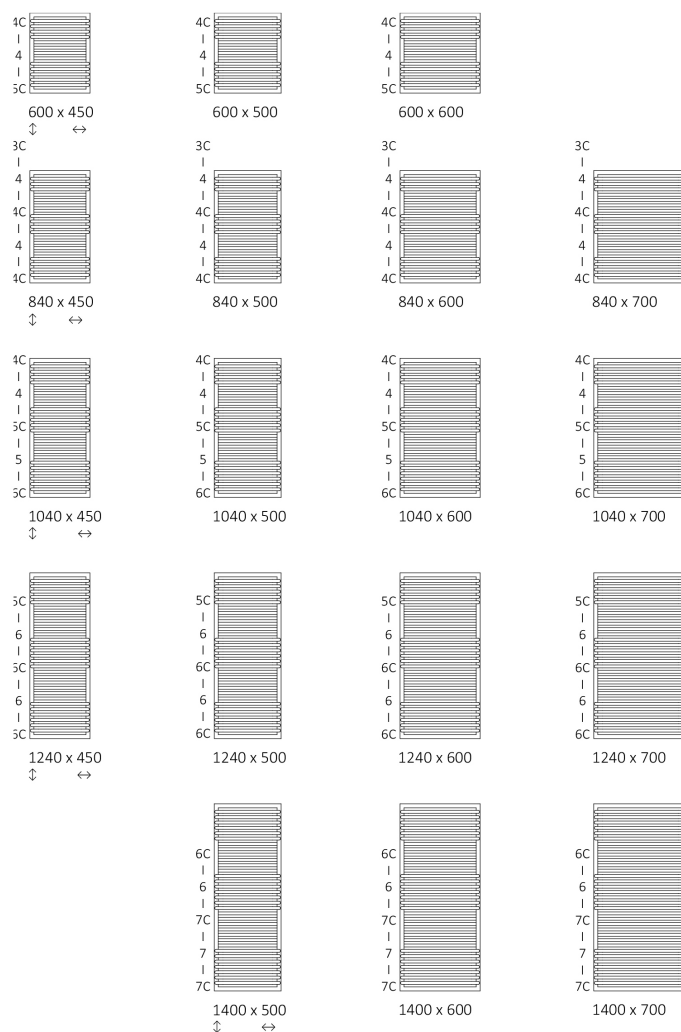

Dimensions disponibles



Poc

Données techniques

Pression du travail : 1,0 MPa Température maximale de travail : 95°C

A ↓	B ↔	C1 [mm]	C2 [mm]	C5 [mm]	75 65 20°C [W]	55 45 20°C [W]	 [W]	D [mm]	E [mm]	F [mm]	 [dm³]	 [kg]
600	450	50	420	500	308	167	300	420	420	90	3,19	6,23
600	500	50	470	500	342	185	400	470	420	90	3,45	6,78
600	600	50	570	500	410	222	400	570	420	90	3,99	7,87
840	450	50	420	500	443	239	400	420	660	90	4,29	8,42
840	500	50	470	500	493	266	600	470	660	90	4,64	9,16
840	600	50	570	500	590	318	600	570	660	90	5,36	10,64
840	700	50	670	500	690	372	800	670	660	90	6,07	12,11
1040	450	50	420	500	556	299	600	420	860	90	5,26	10,38
1040	500	50	470	500	618	332	600	470	860	90	5,70	11,28
1040	600	50	570	500	743	399	800	570	860	90	6,56	13,07
1040	700	50	670	500	866	465	800	670	860	90	7,42	14,87
1240	450	50	420	500	669	359	800	420	1060	90	6,19	12,22
1240	500	50	470	500	744	399	800	470	1060	90	6,70	13,28
1240	600	50	570	500	893	479	1000	570	1060	90	7,71	15,40
1240	700	50	670	500	1041	559	1000	670	1060	90	8,72	17,51
1400	500	50	470	500	844	452	800	470	1220	90	7,53	14,96
1400	600	50	570	500	1013	543	1000	570	1220	90	8,66	17,34
1400	700	50	670	500	1182	633	1200	670	1220	90	9,79	19,71

Poc

SX

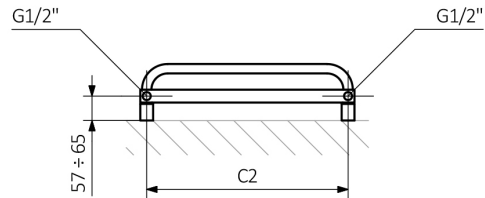

51

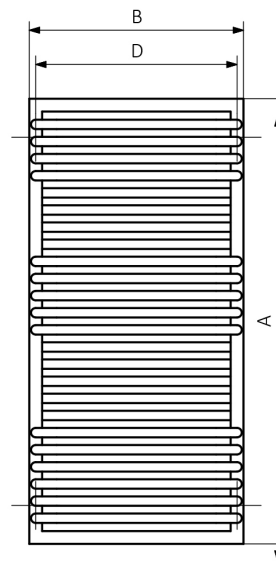
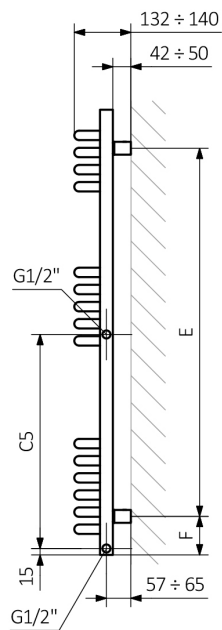
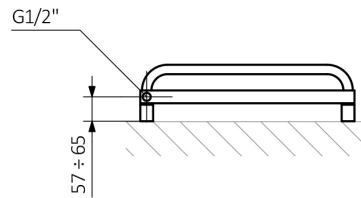

A – hauteur B – largeur C1-C5 – écartement des raccordements D – écartement des consoles en horizontal E – écartement des consoles en vertical F – distance de l'axe de la console inférieure au bord inférieur du collecteur

Collecteur :

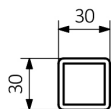

Profil :

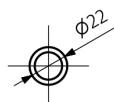

Poc

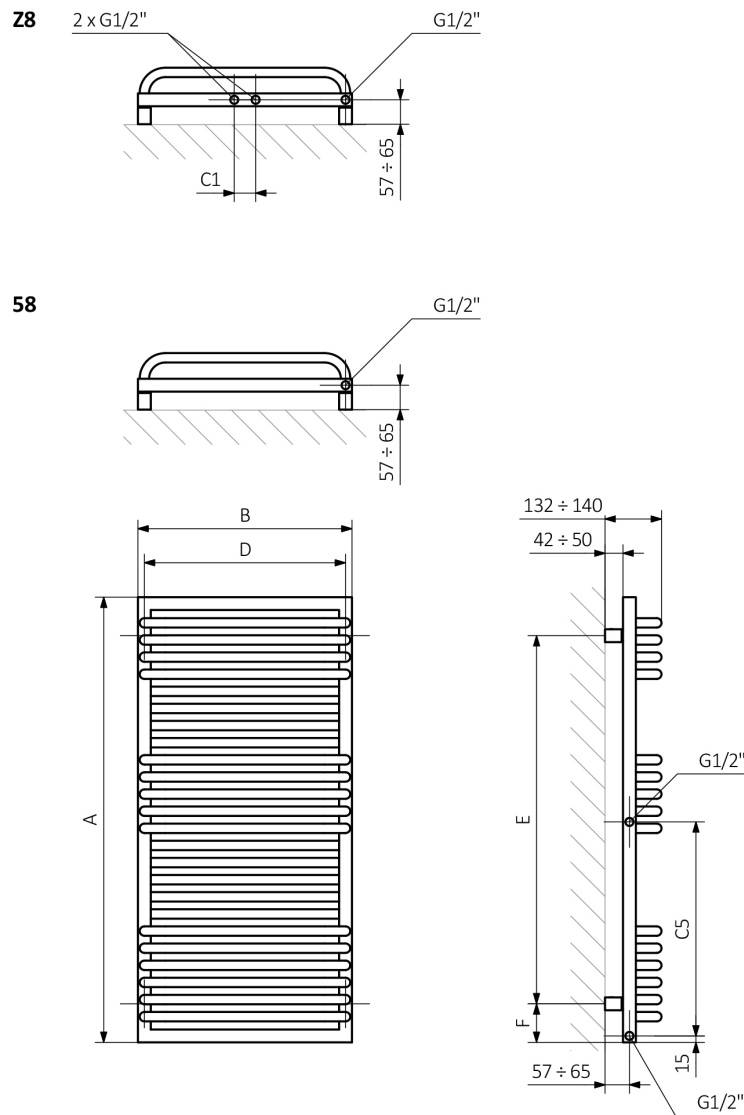

A – hauteur B – largeur C1-C5 – écartement des raccords D – écartement des consoles en horizontal E – écartement des consoles en vertical F – distance de l'axe de la console inférieure au bord inférieur du collecteur

Collecteur :

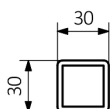

Profil :

