

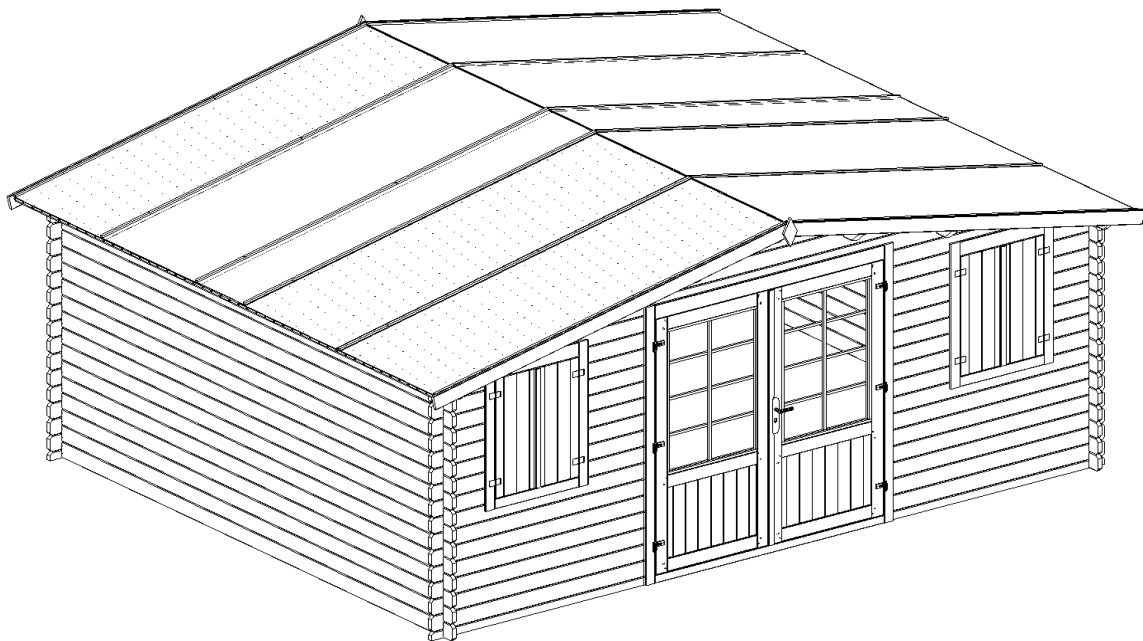

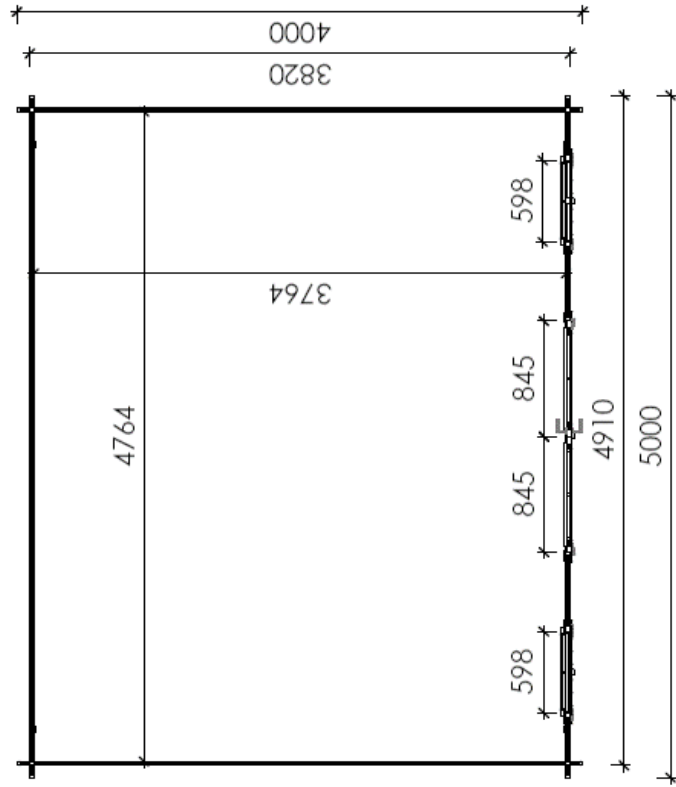

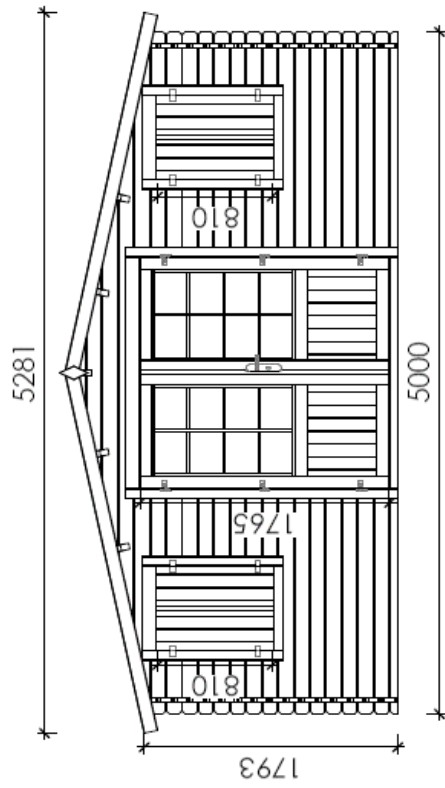

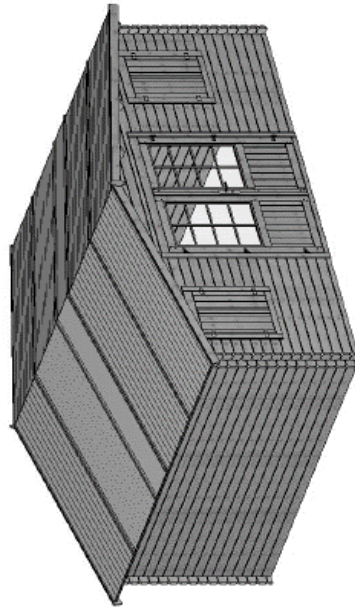

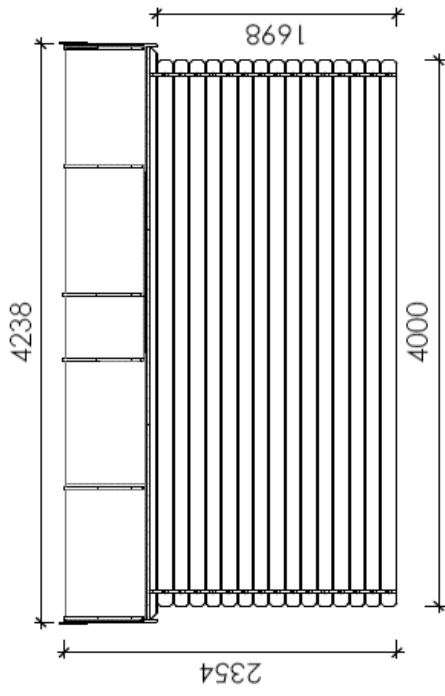





















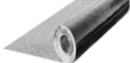
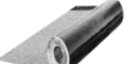











DOM14-7

500X400 28mm





DOM14-7_500x400 28mm						A	B
1		28	121	4000	30		
2		28	113	4200	2		
3		28	121	5000	15		
4		28	65	5000	1		
5		28	65	5000	1		
6		28	121	435	16		
7		28	121	510	16		
8		28	121	1622	14		
9	 SZC12-3	28	559	5000	2		
10		45	145	4200	5		
11	 OSCP01	61	82	1926	1		
12	 OSCL01	61	82	1926	1		
13	 NAD01	61	112	1746	1		
14	 PRO01	16	55	1700	1		
15	 DRZ03-4	38	845	1765	1		
16	 OKNP01-4	83	762	999	1		
17	 OKNL01-4	83	762	999	1		
18		13	45	2000	4		
19		16	99	2660	96		
20		13	22	1150	37		
21		19	95	2700	4		
22		19	110	165	2		
23		3	1000	11200	2		
24		3	1000	5600	1		
25		16	16	1000	18		
26		9	12	850	10		

DOM14-7 500x400 28mm				A	B
A		3,0x30	220		
B		3,5x40	36		
C		4,0x35	54		
D		3,5x60	4		
E		5,0x100	6		
F		2,0x40	768		
G		1,4x30	74		
H		6x50	4		
J			2		
K			2		
M			6		
N		660x1000	2		
O		560x772	2		
P		3,5x25	9		
Q			1		
R			1		
S			4		
T			8		

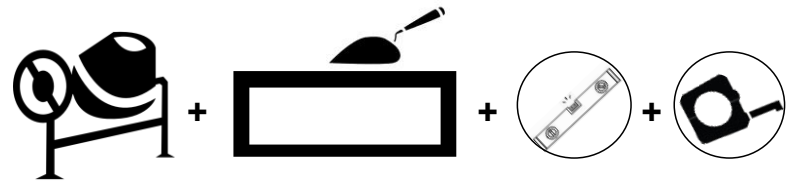
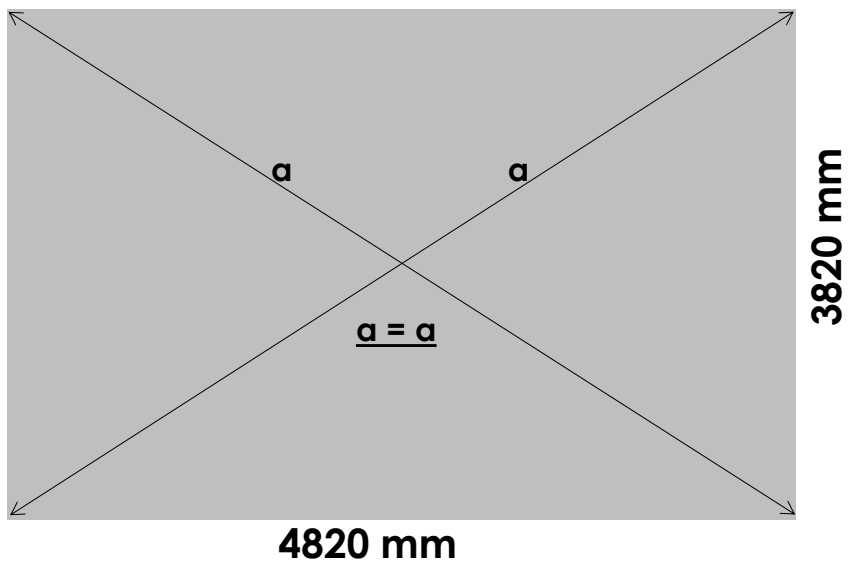
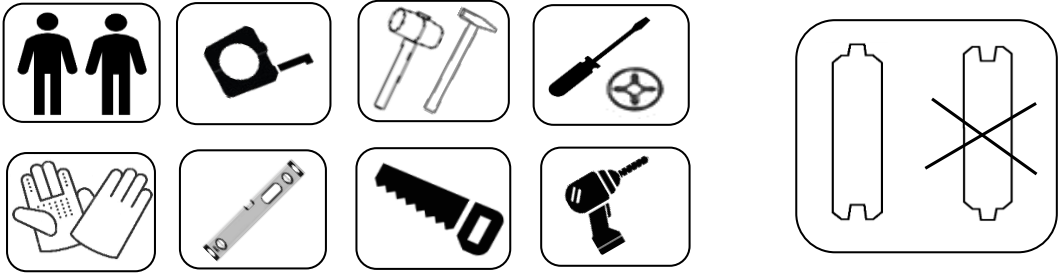

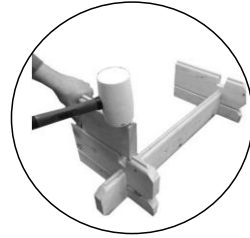
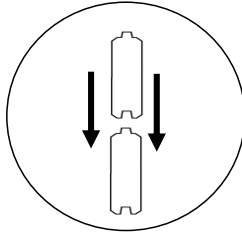
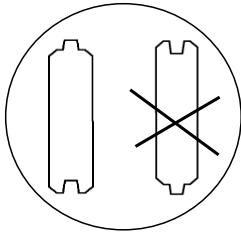

1

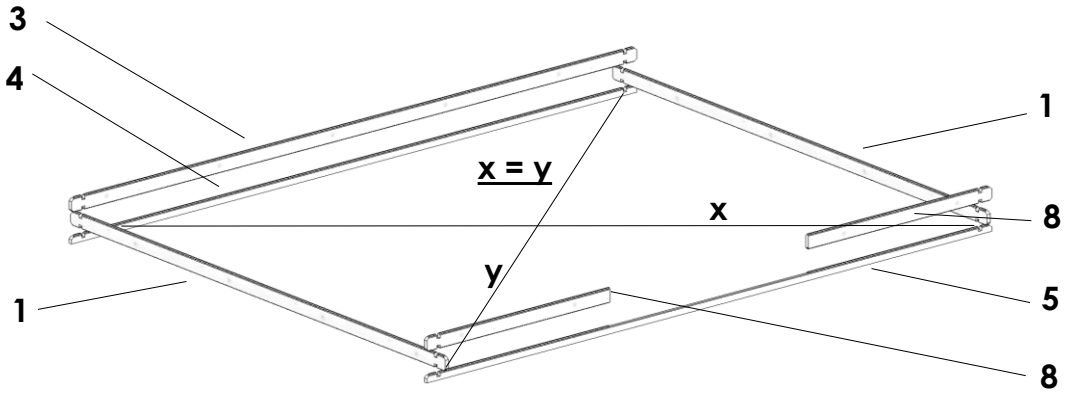

2

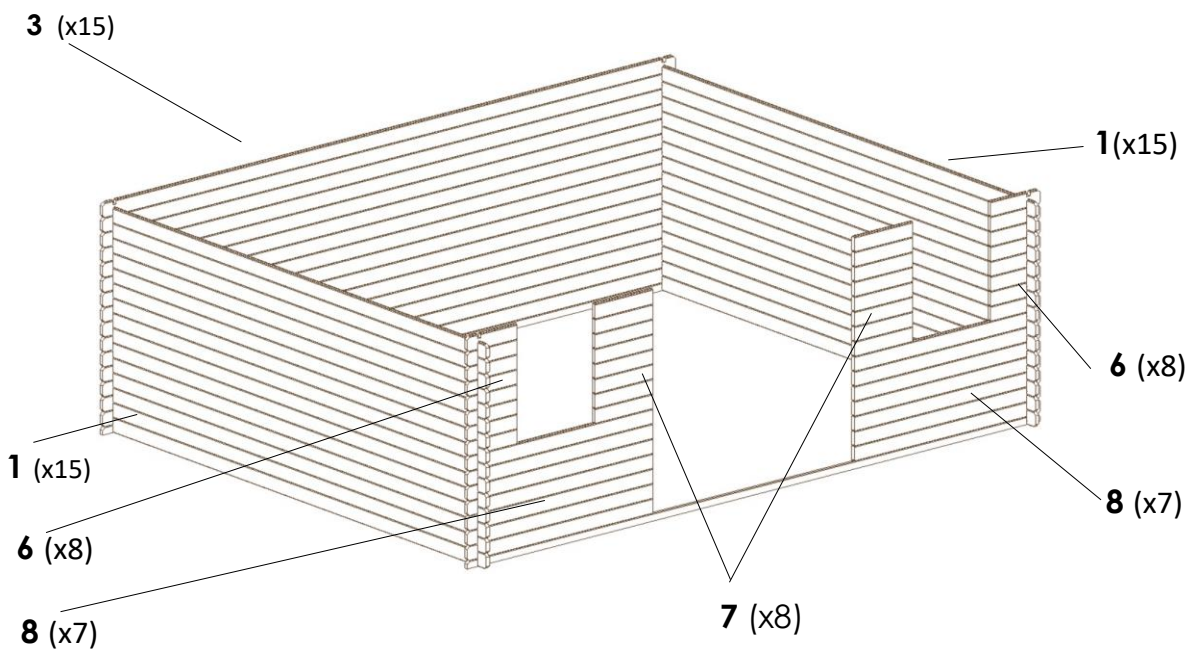

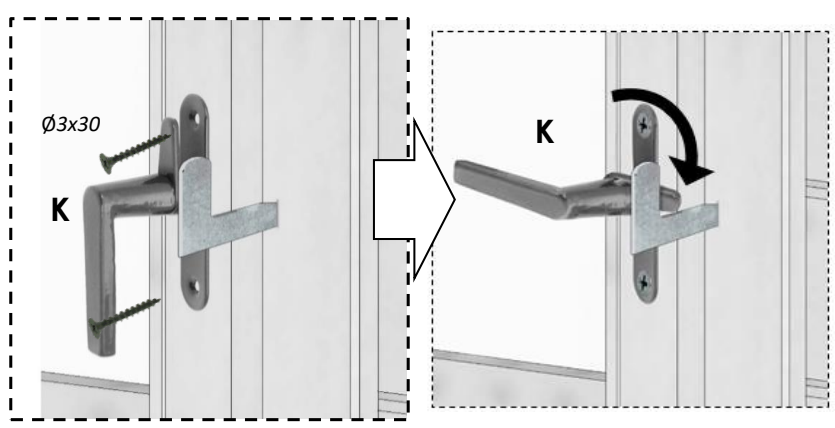
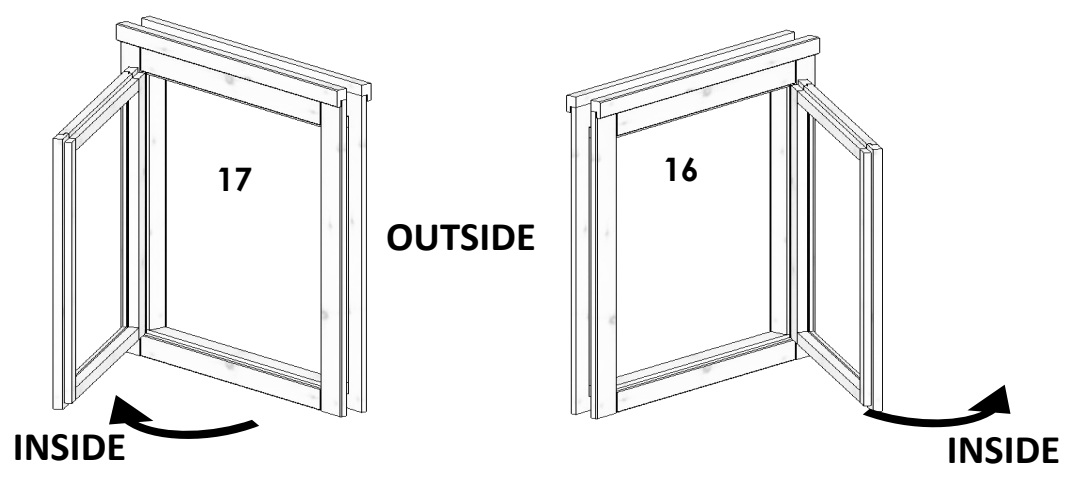
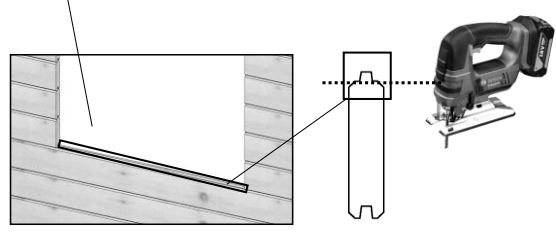
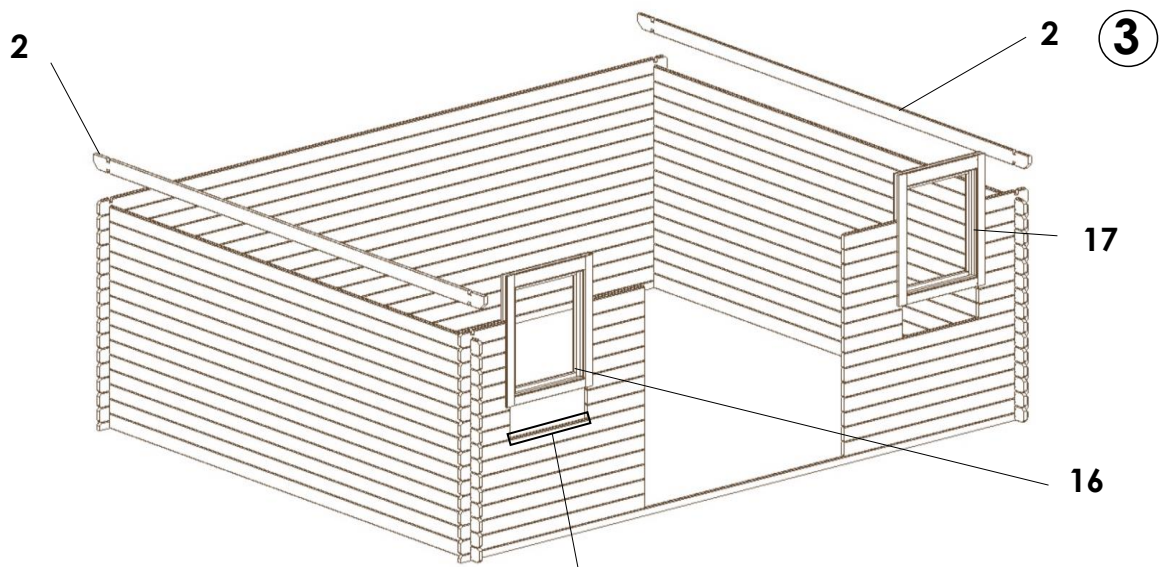

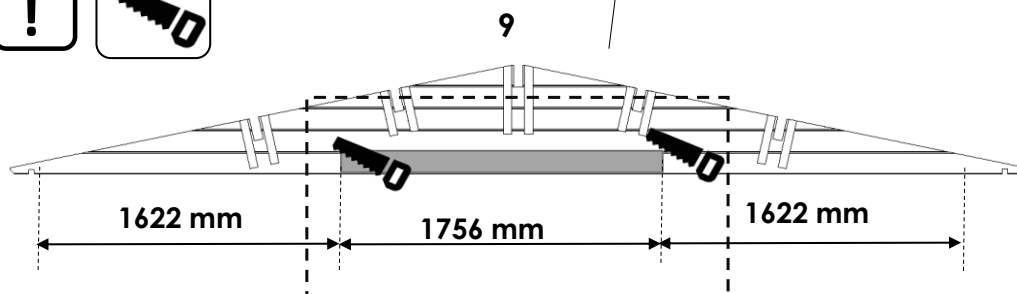
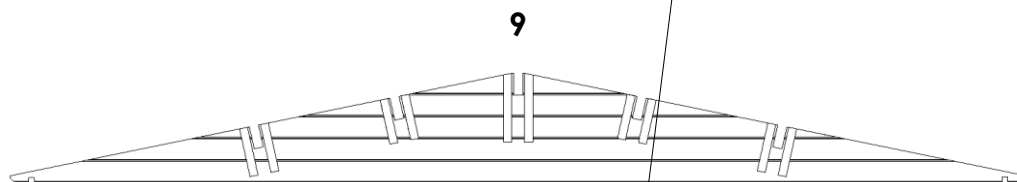
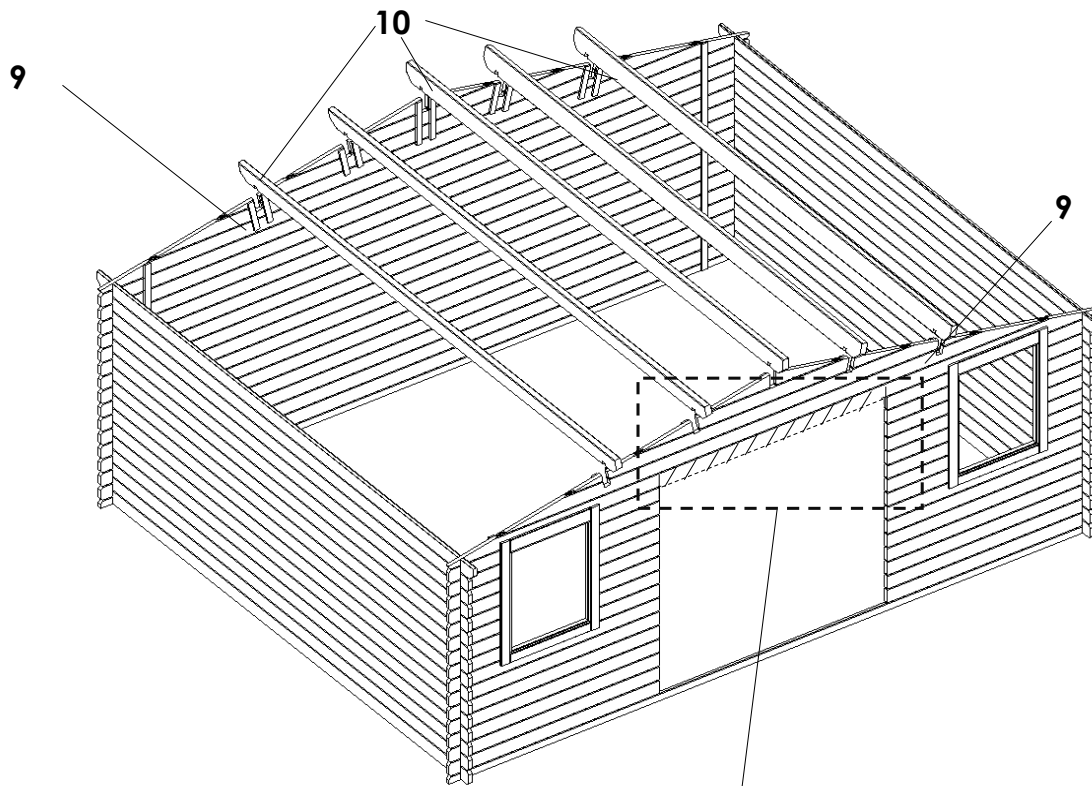

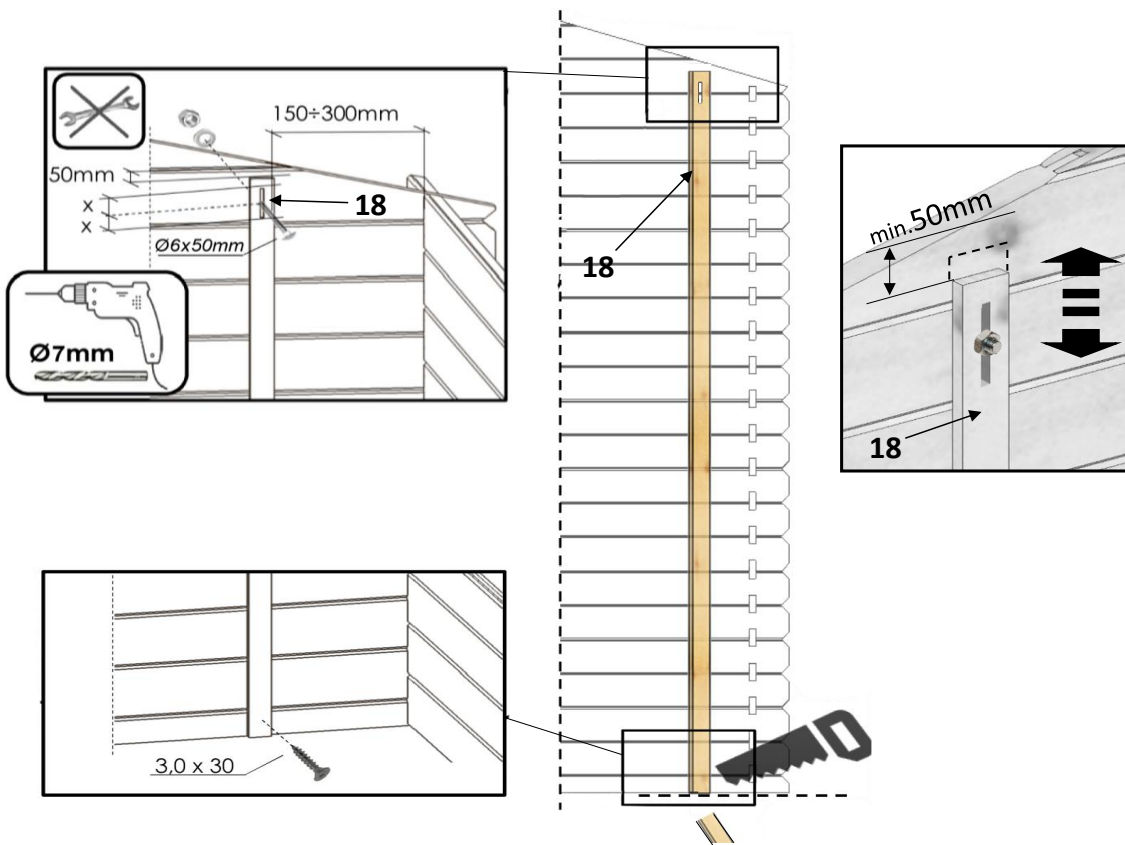
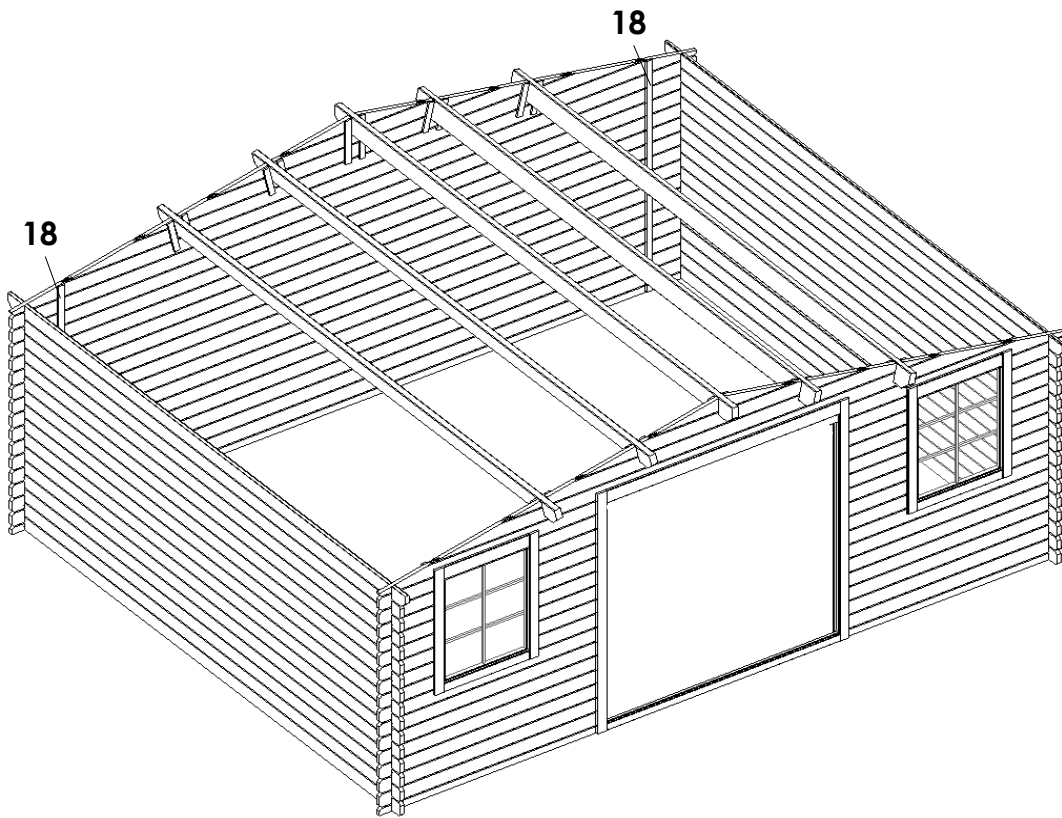

4

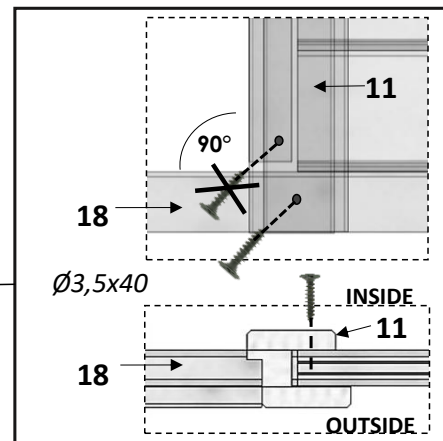
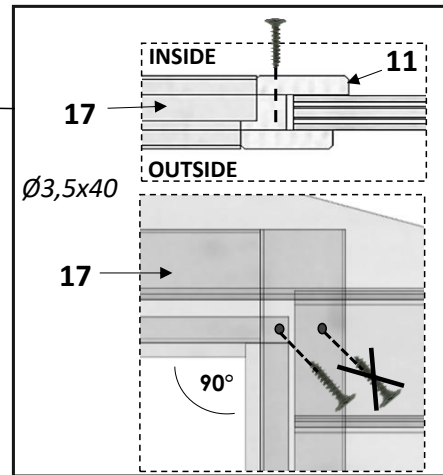
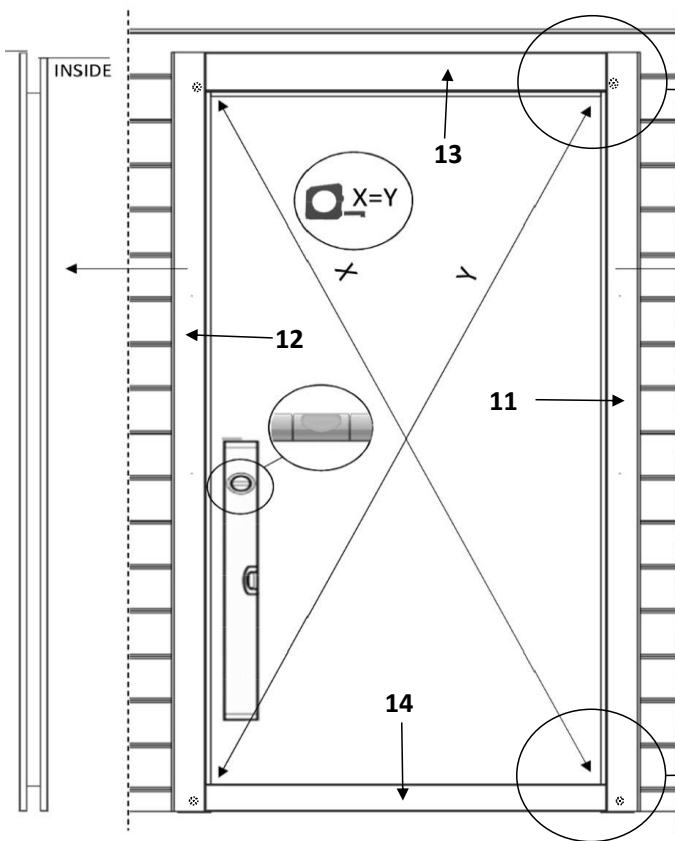
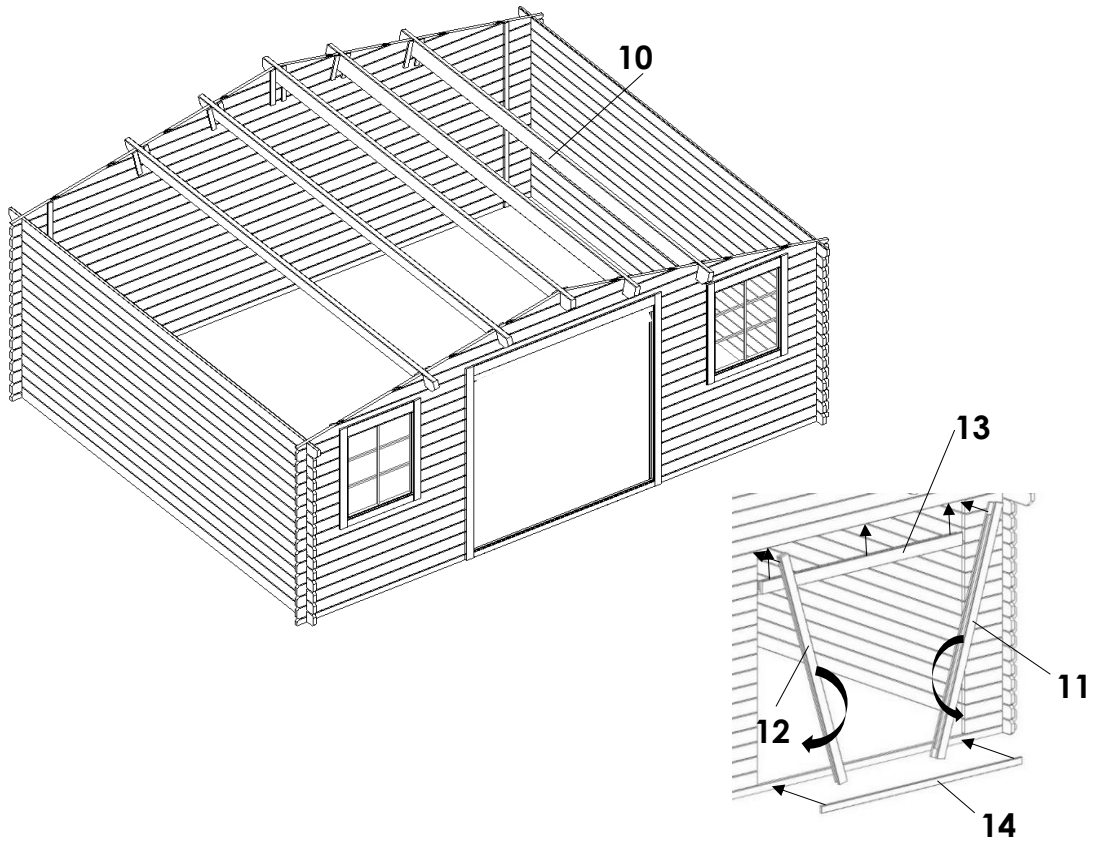

5

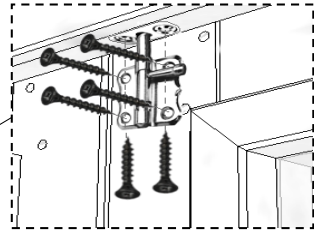
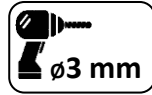
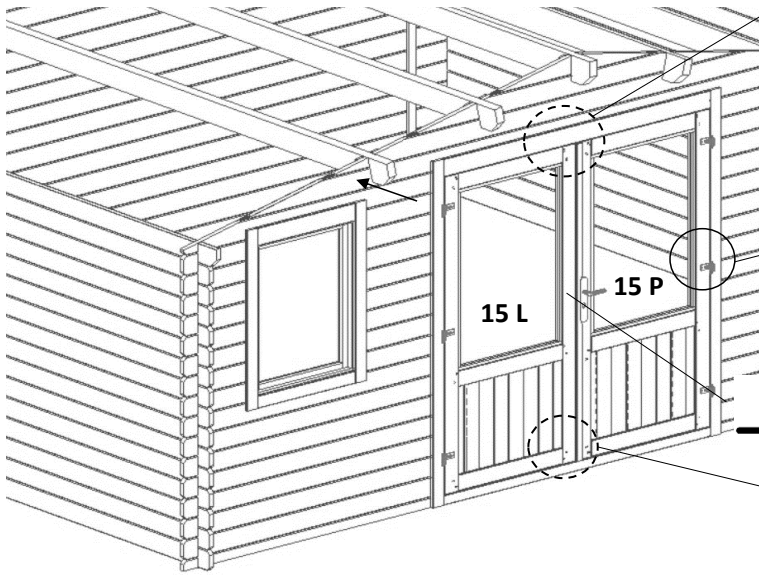

6x Ø4,0x35 INSIDE

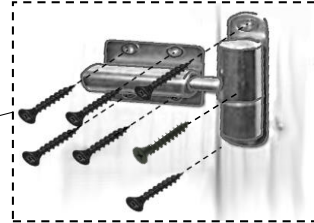

7x Ø4,0x35 OUTSIDE

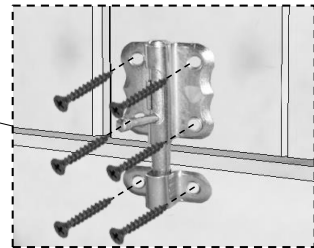

INSIDE

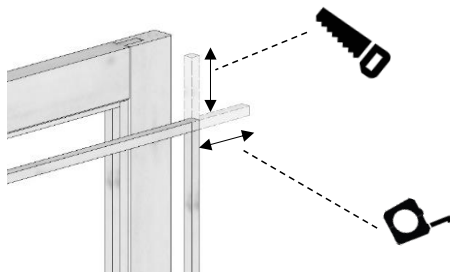

1 20x Ø1,4x30

INSIDE

15R

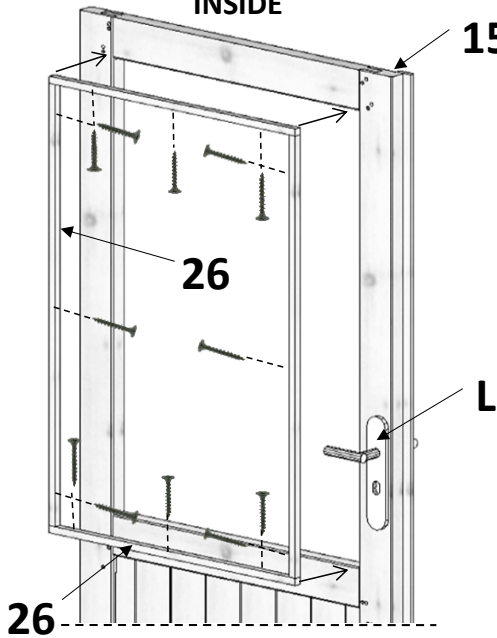

2 20x Ø1,4x30

OUTSIDE

26

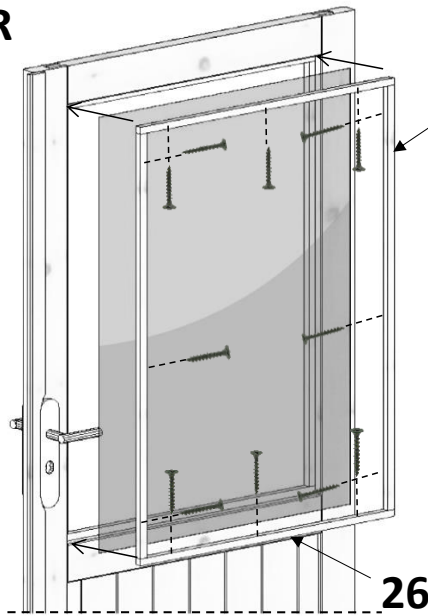

26

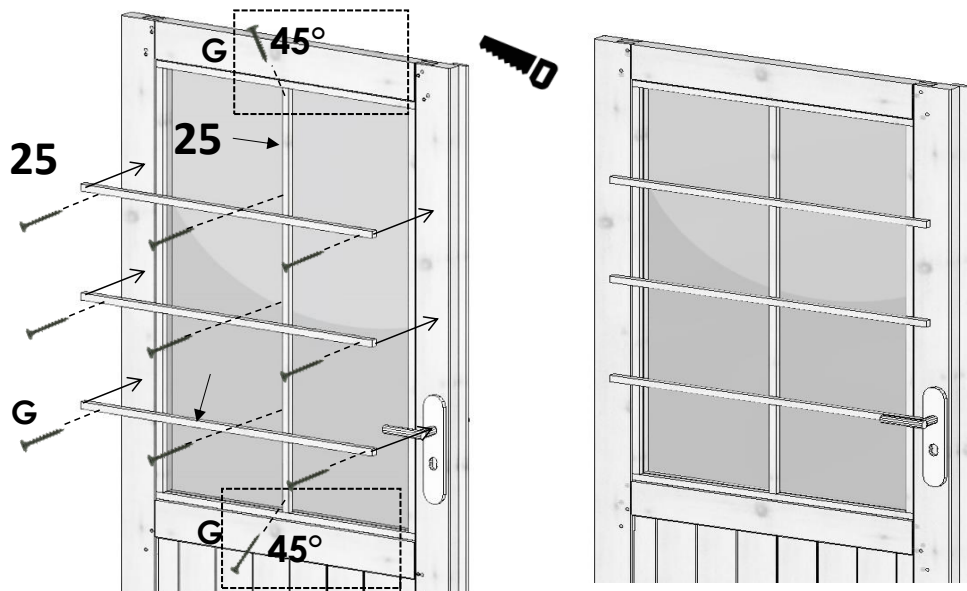

inside

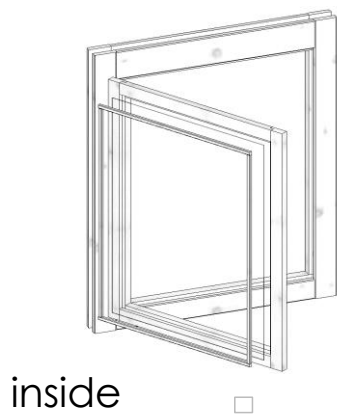

inside

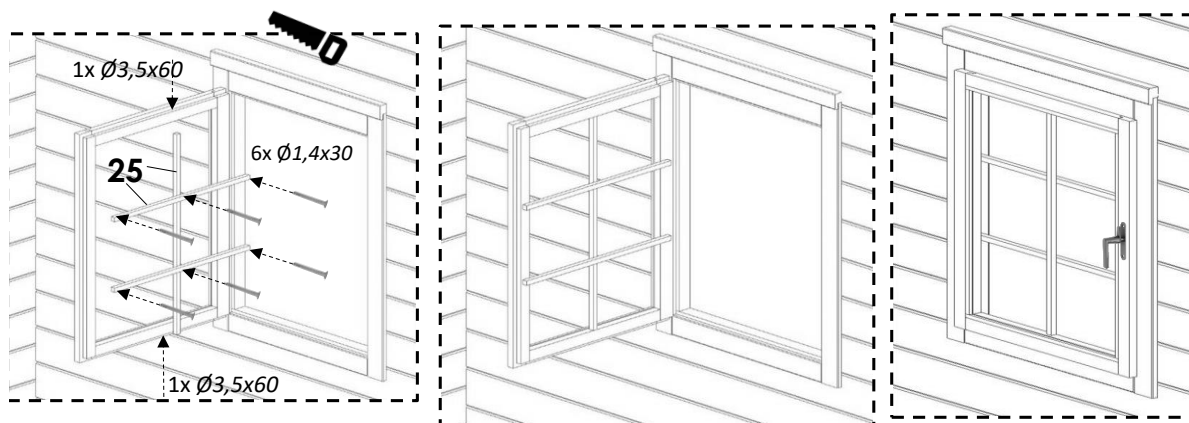
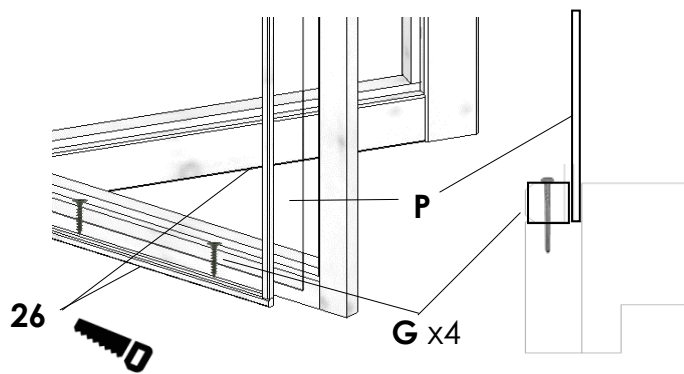

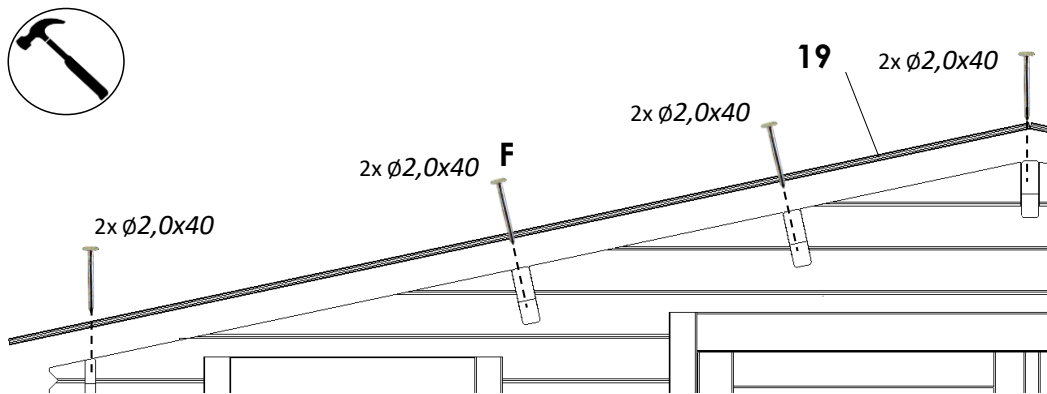
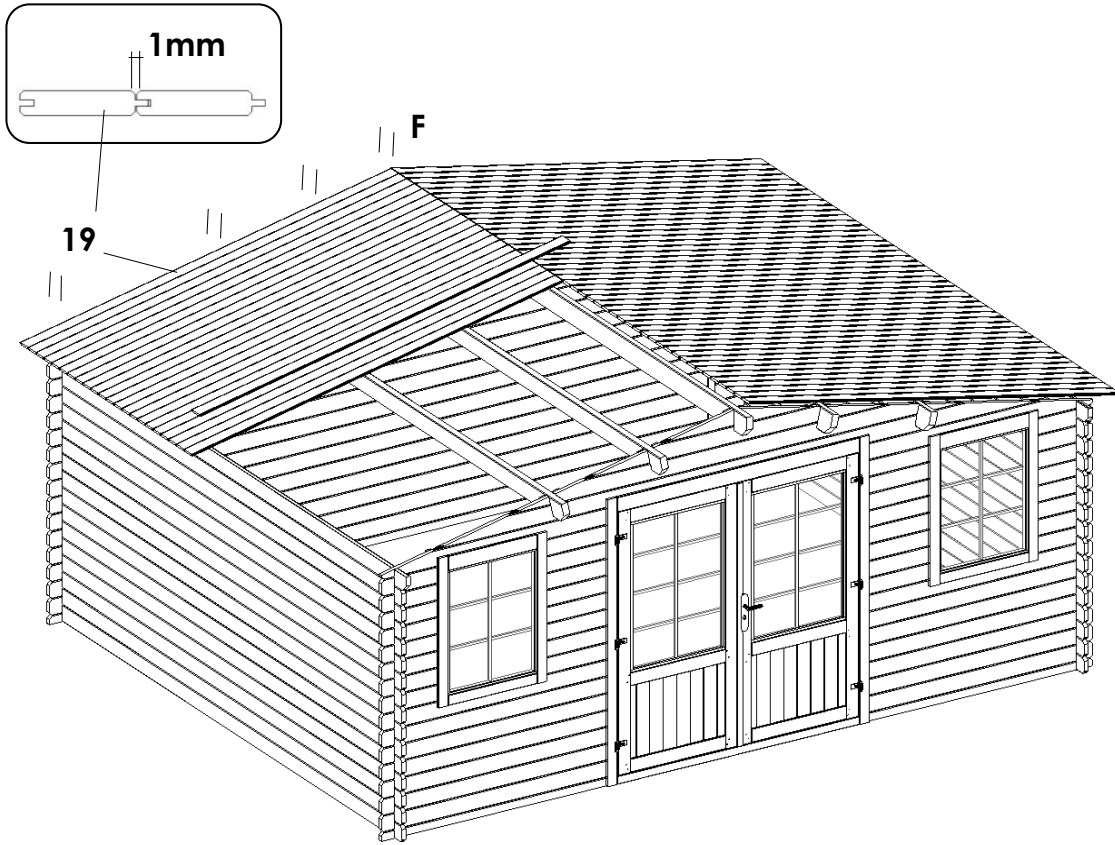

8

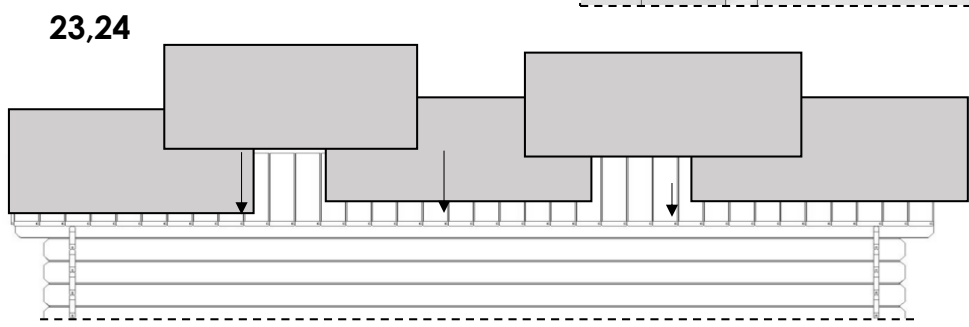
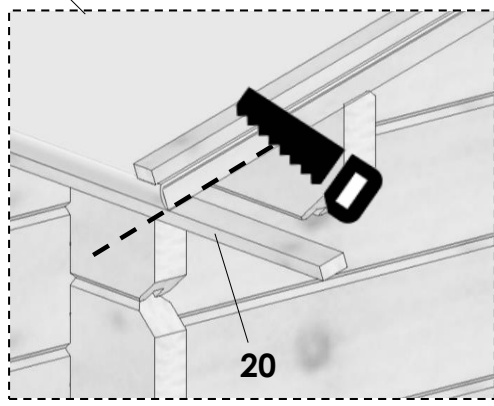
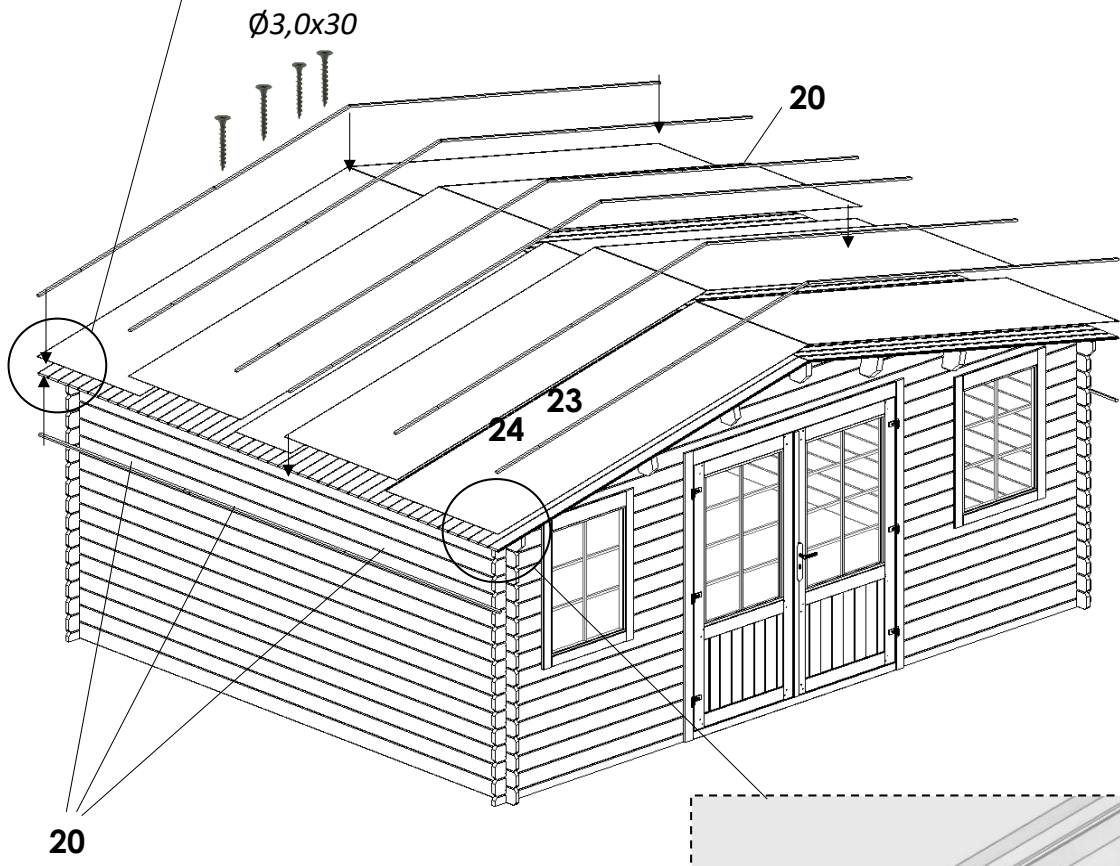
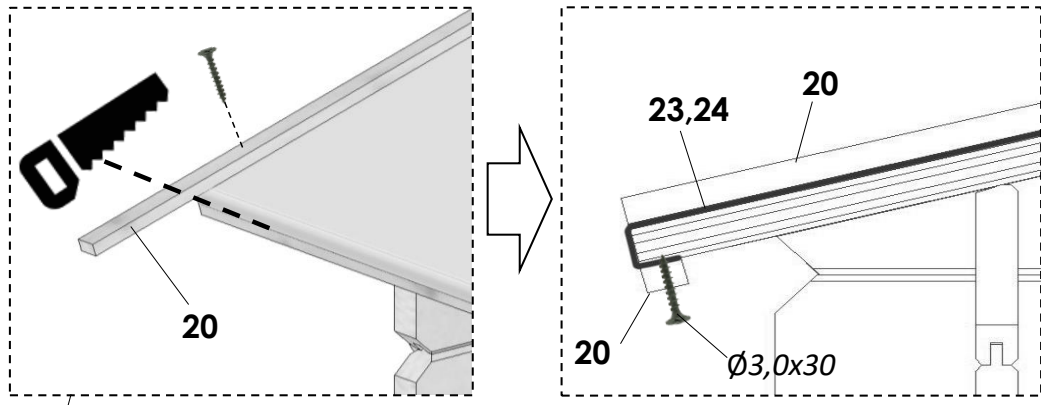

9

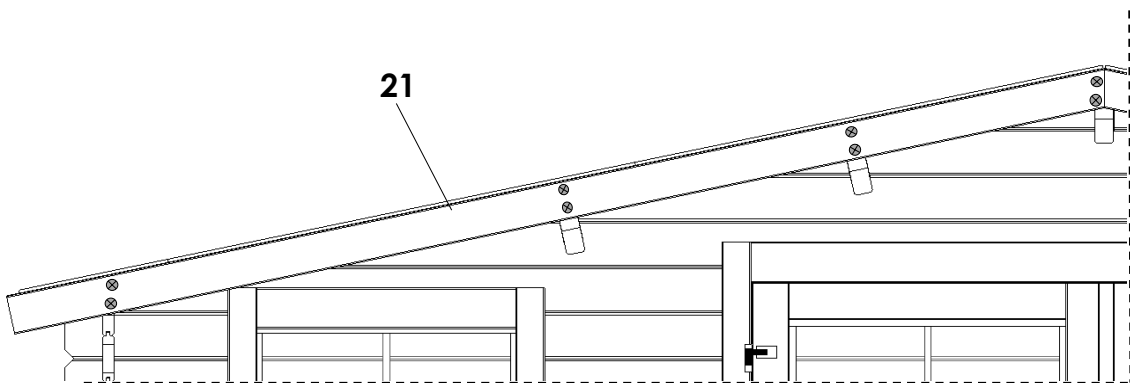
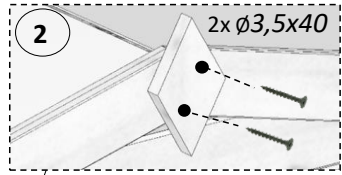
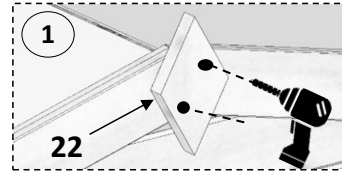
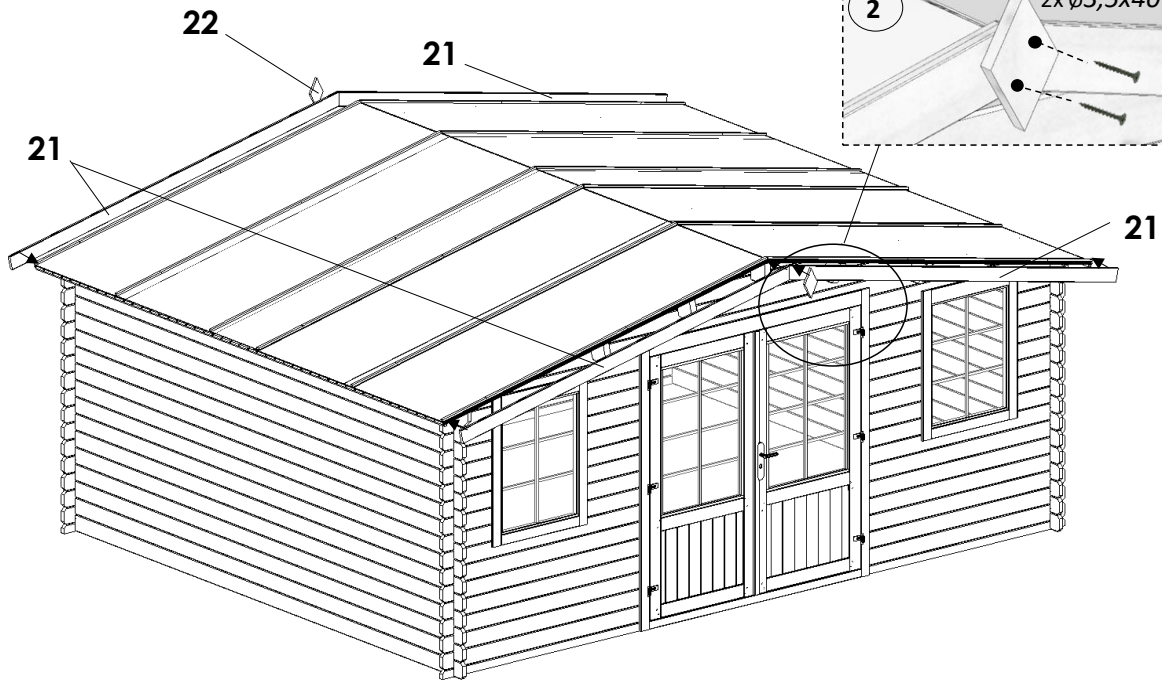

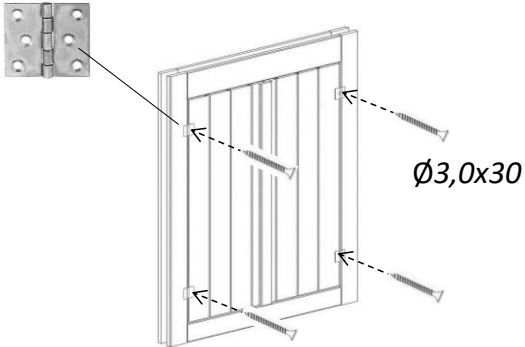
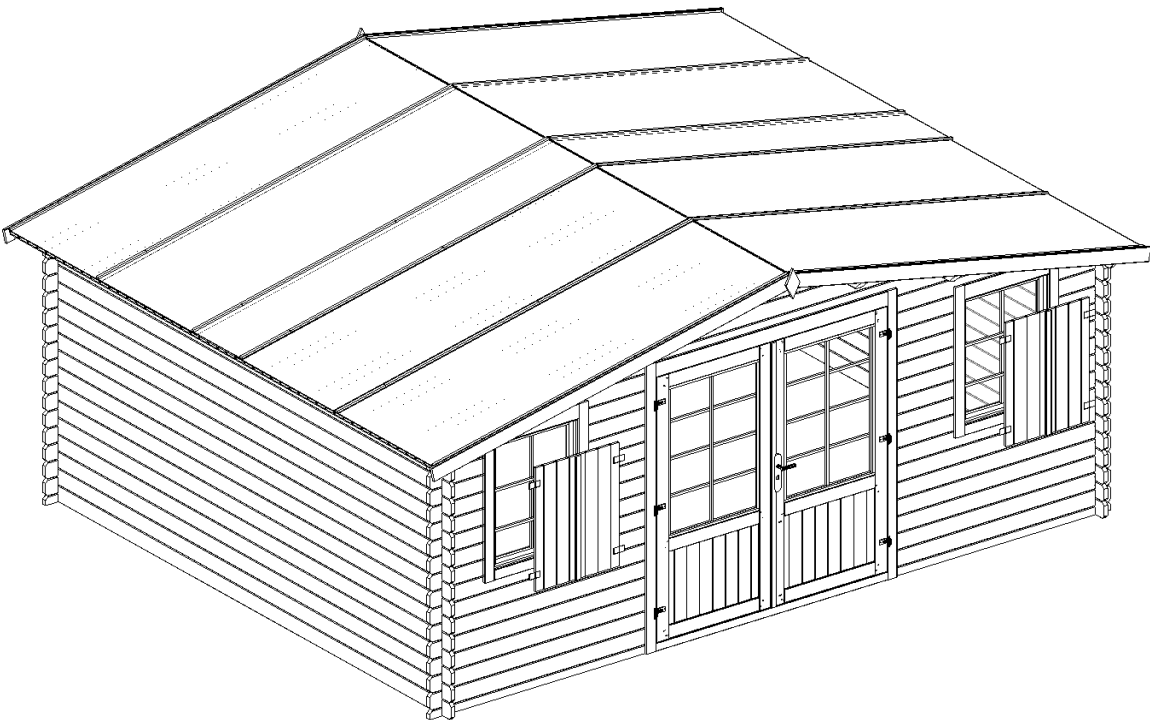

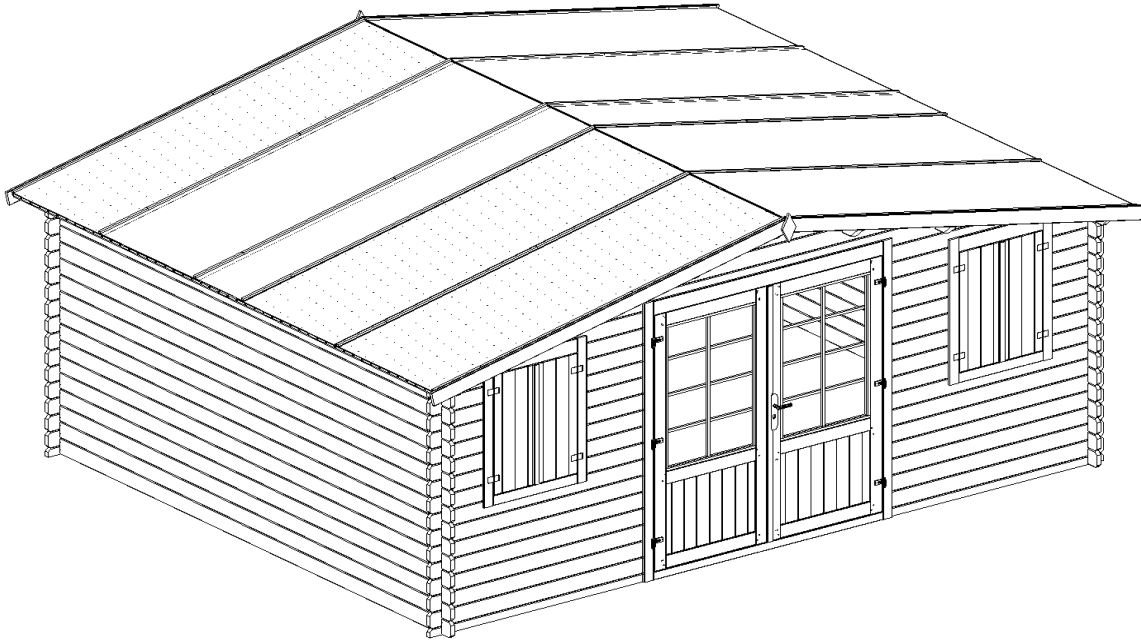

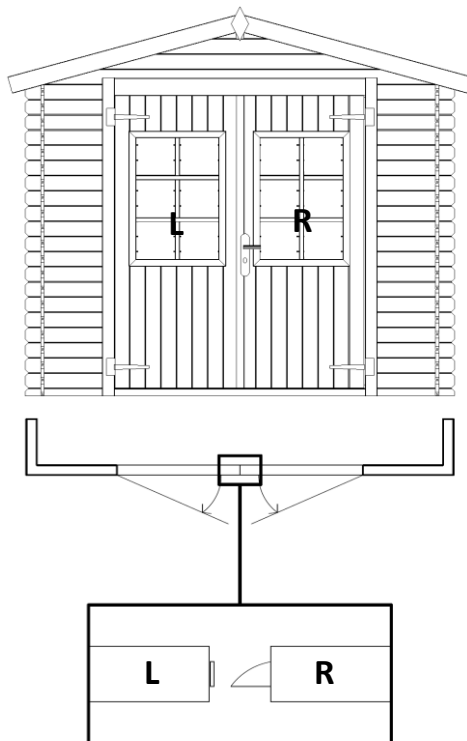
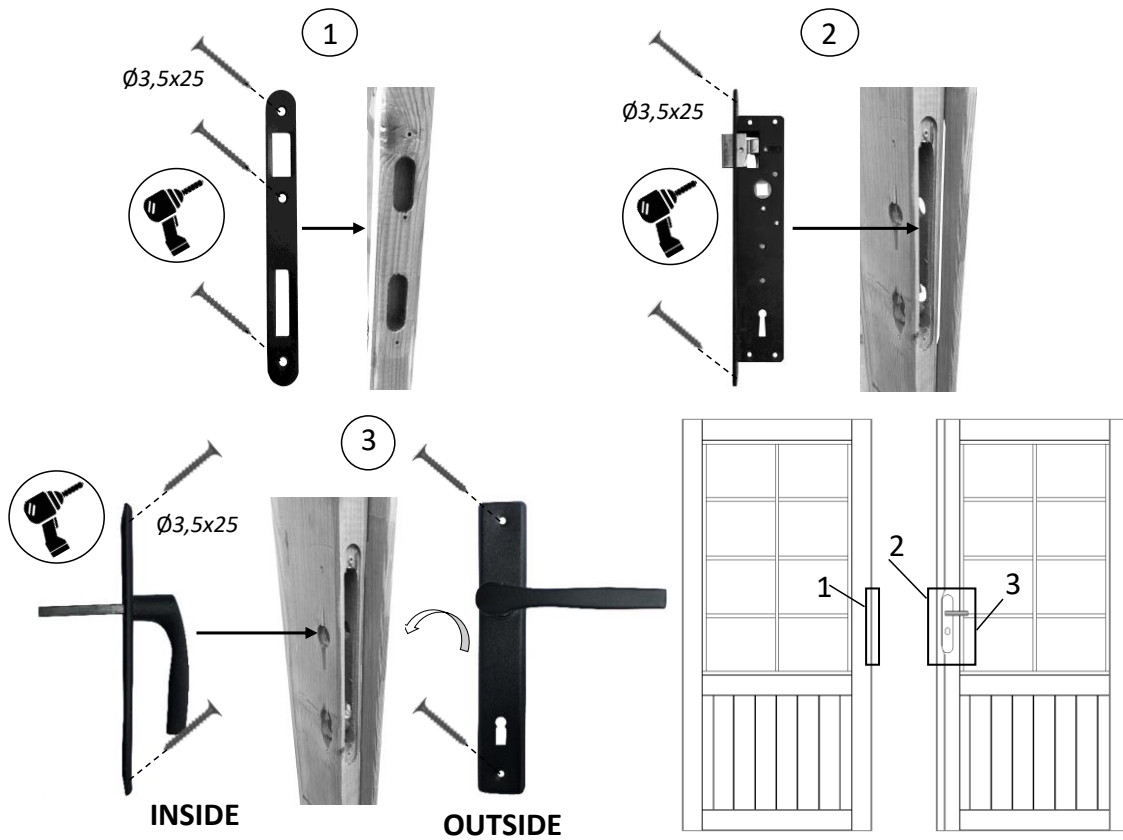

lock - change from the left to the right

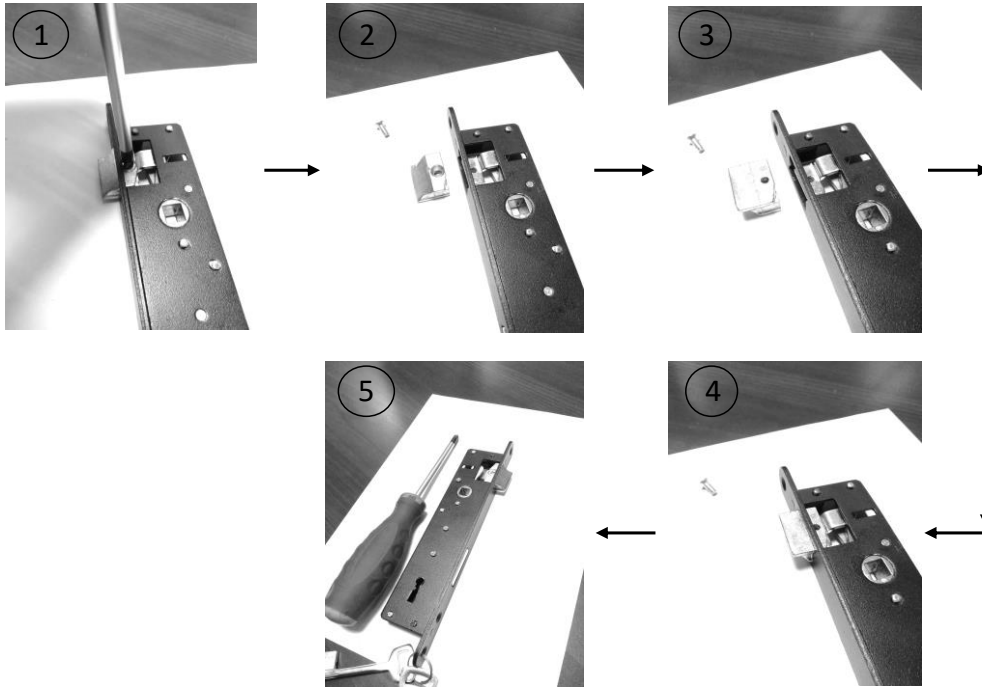

lock - change from the right to the left

